

Vickers®

Cylinders



Series TE/TF/TL Cylinders

Nominal Pressure: 250 psi Air / 1000 psi Hydraulic

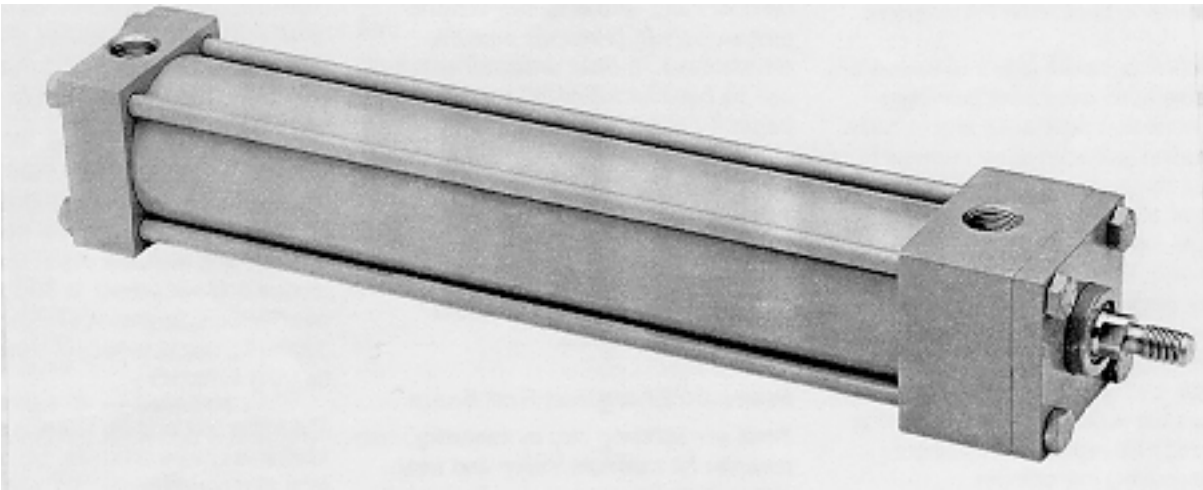

Table of Contents

Features and Benefits	3
How To Order	4
Model Codes	5
Mounting Styles	8
Application Guide for Mountings	
Side Lug	10
Tapped	10
Keyed Side Lug	10
Keyed Tapped	10
Head Rectangular Flange	11
Head Square Flange	11
Clevis	11
Spherical Bearing	12
Cap Rectangular Flange	13
Intermediate Trunnion	13
Cap Trunnion	13
Head Trunnion	14
Cap Extended Tie Rod	14
Head Extended Tie Rod	14
Both Ends Extended Tie Rod	15
Double Rod End, Side Lug and Other Mounts	15
Mounting Dimensions By Cylinder Bore Size	
1 1/2" Bore	16
2" Bore	18
2 1/2" Bore	20
3 1/4" Bore	22
4" Bore	24
5" Bore	26
6" Bore	28
7" Bore	30
8" Bore	32
10" Bore	34
12" Bore	36
14" Bore	38
Accessories for All Cylinders	40
Accessories for Spherical Bushing Mounted Cylinders	43
Common Options	
Rod Sizes and Types	44
Port Types, Sizes and Locations	45
Seal Options	46
Limit Switches	47
PS 200 Proximity Switches	48
Stop Tube, Tie Rod Spacers and Center Supports	50
Application / Engineering Data	
Selecting Cylinder Size	51
Piston Velocity	53
Maximum Allowable Push Strokes	55
Cushioning System	59
Cylinder Weights	60
Hydraulic Formulas	61

Features and Benefits

Hard Chrome Plated Piston Rod.

100,000 psi minimum yield strength steel, polished to 8 micro inch finish. Provides extra corrosion resistance and virtually eliminates galling or other damage from normal contaminants.

Urethane Rod Wiper is self compensating for extended wear and is standard on air cylinders. Dual metallic rod scrapers are standard for hydraulic service and optional for air service.

QC-100 Quick-change Rod Bearing Assembly permits easy replacement of rod seals without disassembling cylinder.

Fe₃N Cast Iron Rod Bearing is result of extensive testing and retesting of bearing materials in exceptionally tough applications with high side loads, high temperatures and abrasive contamination. Provides high load capacity and extremely long life.

Special nitriding process surface hardens close-grain cast iron to reduce wear while adding corrosion resistance. FE₃N bearings are up to 98% more durable than typical bronze bearings.

Pressure Energized Rod Seals are activated only by operating pressure for minimum friction and wear. Multiple-lip seal provides three seals in one. Male bronze seal adapter maintains alignment and permits seal response to pressure.

Full-flow NPTF Ports minimize pressure drop on inlet or outlet. SAE ports are recommended in Series TF hydraulic applications.

Steel Heads and Mountings.

Machined relief for rapid fluid flow to piston.

Externally Adjustable Cushion Screws

Super Cushion Seals featured on TE/TL air cylinders. Resilient lip design eliminates metal-to-metal contact and need for ball checks.

Series TF hydraulic cylinders are identical to Series TE, except cushioned models have patented floating ring super cushion seal. Floating action of ring permits it to absorb external piston rod side loading without binding.

Both cushion systems provide positive cushion sealing with minimum wear and maximum piston acceleration on return stroke.

Hard Chrome Plated Body.

Steel tubing is precision honed to provide optimum surface finish for maximum piston seal life. Provides extra corrosion resistance and virtually eliminates galling or other damage from normal contaminants.

125,000 psi Minimum Yield Strength Steel Tie Rods

One-piece Piston is solid cast iron for maximum bearing surface with easy seal replacement.

U-cup Type Piston Seal.

This pressure energized lip seal provides minimum friction and long life.

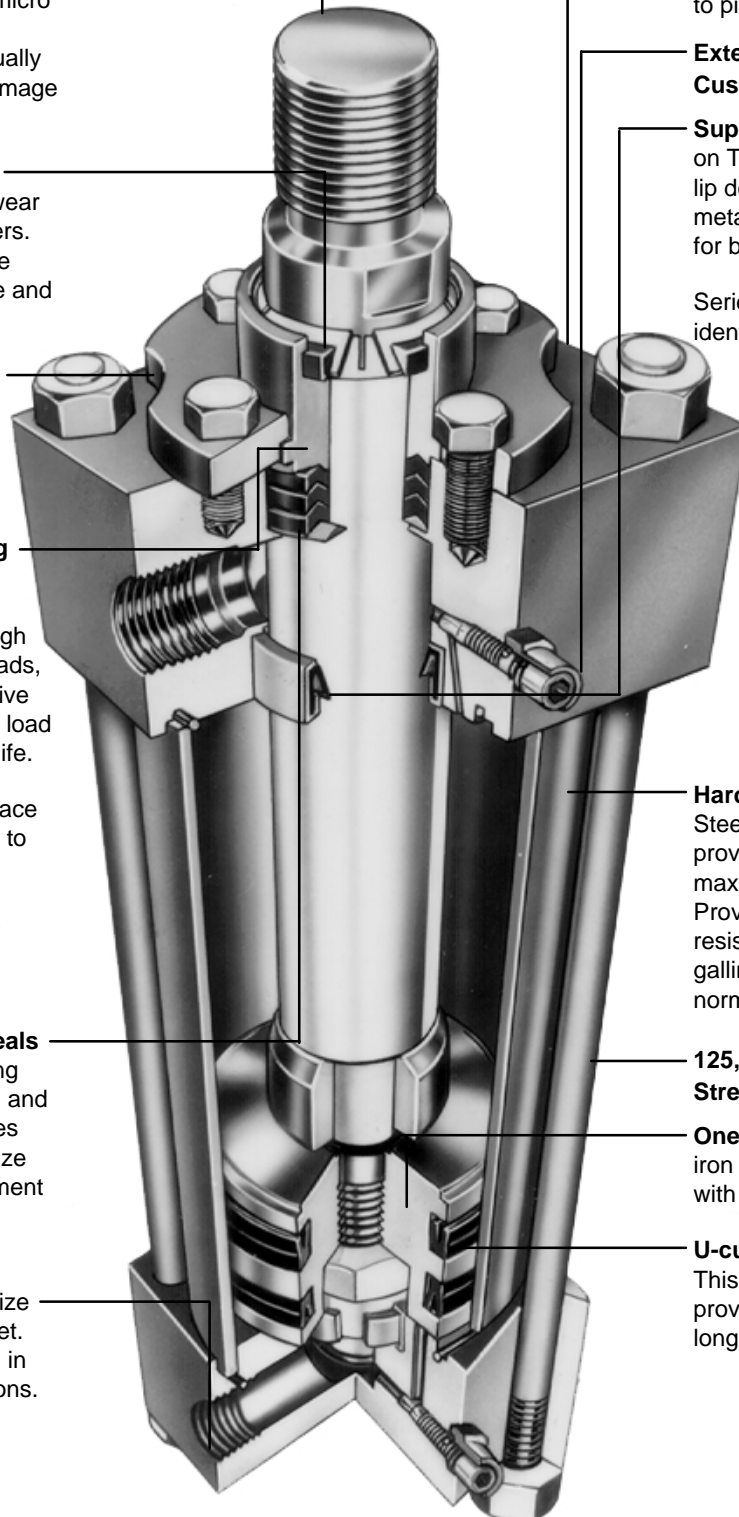

Built-in Limit Switches

Series TE/TF/TL cylinders can be specified with built-in limit switches or air pilot valves. Three types of electrical limit switches are available. The actuators for these switches and valves are built into the cylinder heads while the switches and valves themselves are housed in an easily accessed protective box which is attached to the head. Conduit connections allow you to fully enclose the wire or air line leads to these switches or valves.

Built-in Proximity Switches

Series TE/TF/TL cylinders can be specified with built-in proximity switches for your logic controlled system. These switches are bolted or threaded into the cylinder head and inductive sensing probes are fully protected from the environment. Built-in proximity switches are available as special options and can be specified for AC or DC service.

TL Nonlube Air Cylinder

The Series TL has been specifically designed and proven to operate for millions of cycles in nonlubricated systems. The Series TL cylinder eliminates the need for internal or external oil supplies for lubrication.

Conventional designs are, for the most part, minor modifications to standard cylinders. The results are a temporary prelubricated cylinder rather than a true nonlubricated one. Most of these modifications entail wicks, oil reservoirs or oil impregnated materials. These forms of lubrication only address a portion of the nonlubricated air operating problem.

Vickers design engineers resolved the specific problems of nonlubricated air operation and designed the Series TL cylinder with features which were both unique and necessary. In addition to new Teflon suspension lubricants, the Series TL has specialized seals and bearing surfaces.

The extremely long-life Teflon suspension lubricants ensure continued performance long after conventional lubricants have been extruded or wiped away. Glass-filled Teflon piston seals, and Teflon with carboxylated nitrile rod seals, add lubrication, reduce friction, and increase long term durability. Also, the lubricants in Vickers Series TL cylinders will not contaminate your nonlubricated air system, as may conventional cylinder lubricants.

Series TL cylinders can be used interchangeably between nonlubricated and lubricated systems. The cylinders are excellent for use in lubricated systems that are irregularly serviced and which may inadvertently become nonlubricated systems. Also, in lubricated systems, the Series TL provides system safety should the lubricator fail.

How To Order Standard Cylinders

Vickers has created an easy system for ordering cylinders. This system has been developed to improve our service to you. The model code consists of sixteen alpha-numeric digits which fully describe the most common standard options. See pages 5 through 7 for a summary of model code options.

To specify your cylinder, review the following pages for a full description of each option available and select the desired code.

This model code system will:

- **Simplify the re-order process.**
Each cylinder is assigned a sixteen digit model code. That code is unique to a particular cylinder description. That way, when you re-order your cylinder, you're assured of exactly the same top quality cylinder design.
- **Improve identification.**
Every cylinder has its sixteen digit model code clearly marked on the product...impression-stamped in the metal head or cap. Each sixteen digit code completely describes a specific

cylinder. This allows seals and replacement components to be easily identified in the field.

- **Facilitate communications.**

This fully descriptive model code system allows you to work directly with your local Vickers sales engineer to identify and service your Vickers cylinder.

Custom Cylinders

New Cylinders

Although the model code has been arranged to cover the vast majority of available options, there will be occasions when you require an option which cannot be coded. When specifying such an option, enter an "X" for the appropriate item in the sixteen digit model code, then describe your requirements. For example, if you have an application which requires a custom thread on the end of the piston rod, enter an "X" for item 7. Then add a full description at the end of the model code, such as "With 1" diameter piston rod with 2" total rod projection and 1"-14 thread 1 1/2" long." The cylinder will then be given a unique five digit design number on receipt of order (as explained below).

Replacement Cylinders

Every Vickers custom cylinder is assigned a unique design number. This number is contained in the last five digits of the sixteen digit model code. In other words, the "Stroke" and "Extra Rod Projection" locations (items 12 through 16) become the "Design Number" items for custom cylinders. When ordering a replacement cylinder, simply give the sixteen digit model code or the five digit design number to your local Vickers Sales Representative.

Replacement Parts

Each design number is stored in a quick retrieval computerized storage system. This gives our field sales representatives rapid access to assist you in identifying and specifying genuine Vickers replacement parts.

Model Codes

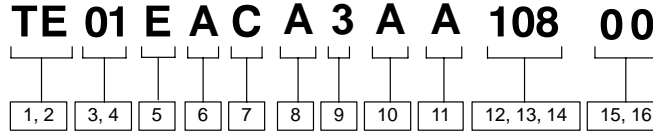

1, 2 Series

- TE** – ANSI B93.15/NFPA
250 psi air cylinder
- TF** – ANSI B93.15/NFPA
1000 psi hydraulic cylinder
- TL** – ANSI B93.15/NFPA
250 psi nonlube air cylinder

3, 4 Mounting style

Vickers Code	ANSI Code
01 – Side lug	MS2
02 – Tapped	MS4
04 – Keyed side lug	–
05 – Keyed tapped	–
07 – Head rectangular flange	MF1† ME3‡
08 – Head square flange	MF5†
10 – Clevis	MP1
11 – Spherical bearing	–
12 – Cap rectangular flange	MF2† ME4‡
13 – Cap square flange	MF6†
15 – Intermediate trunnion	MT4
16 – Cap trunnion	MT2
17 – Head trunnion	MT1
21 – Cap extended tie rod	MX2
22 – Head extended tie rod	MX3
23 – Both ends extended tie rod	MX1
24 – No mount	–
25 – Double rod, side lug	–
26 – Double rod, tapped	–
28 – Double rod, keyed side lug	–
29 – Double rod, keyed tapped	–
31 – Double rod, rectangular flange	–
32 – Double rod square flange	–
34 – Double rod, intermediate trunnion	–
35 – Double rod, head trunnion	–
39 – Double rod, head end extended tie rod	–
40 – Double rod, both ends extended tie rod	–
41 – Double rod, no mount	–

(See detailed information on page 8.)

† Applies to 1 1/2" through 6" bores only
‡ Applies to 7" through 14" bores only

5 Bore size (in inches)

Code	Bore
C –	1 1/2
D –	2
E –	2 1/2
G –	3 1/4
H –	4
K –	5
L –	6
M –	7
N –	8
R –	10
S –	12
T –	14

(See detailed information on page 51.)

6 Cushion & adjustment position

Cushions are located as shown below when viewing cylinder from head end (mounting end of double rod cylinder). "–" in table indicates no cushion.

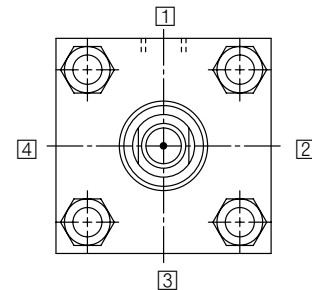

Code	Head	Cap
A –	–	–
B –	–	1
C –	–	2
D –	–	3
E –	–	4
F –	1	–
G –	2	–
H –	3	–
J –	4	–
K –	1	1
L –	1	2
M –	1	3
N –	1	4
P –	2	1
R –	2	2
S –	2	3
T –	2	4
U –	3	1
V –	3	2
W –	3	3
Y –	3	4
1 –	4	1
2 –	4	2
3 –	4	3
4 –	4	4

Double Rod Cylinders:
"Head" = "Mounting" end
"Cap" = "Non-mounting" end

Model Codes

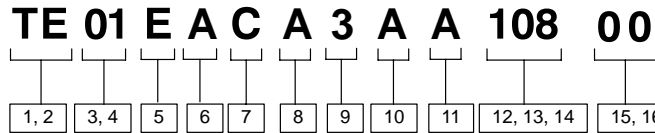

7 Rod size and rod end type

Bore size (inch)	Rod size (inch)	Code (for rod size and rod end type)			
		"2" rod end type	"4" rod end type	"5" rod end type	"6" rod end type
1 1/2	5/8	A	B	C	D
	1*	E	F	G	H
2	5/8	A	B	C	D
	1	E	F	G	H
	1 3/8	J	K	L	M
2 1/2	5/8	A	B	C	D
	1	E	F	G	H
	1 3/8	J	K	L	M
	1 3/4	N	P	R	S
3 1/4	1	A	B	C	D
	1 3/8	E	F	G	H
	1 3/4	J	K	L	M
	2	N	P	R	S
4	1	A	B	C	D
	1 3/8	E	F	G	H
	1 3/4	J	K	L	M
	2	N	P	R	S
	2 1/2	T	U	V	W
5	1	A	B	C	D
	1 3/8	E	F	G	H
	1 3/4	J	K	L	M
	2	N	P	R	S
	2 1/2	T	U	V	W
6	3	Y	1	2	3
	3 1/2	4	5	6	7
	1 3/8	A	B	C	D
	1 3/4	E	F	G	H
	2 1/2	J	K	L	M
6	4	N	P	R	S

*Cushion cap end only on series TE and TL for this bore/rod combination.

Bore size (inch)	Rod size (inch)	Code (for rod size and rod end type)			
		"2" rod end type	"4" rod end type	"5" rod end type	"6" rod end type
7	1 3/8	A	B	C	D
	1 3/4	E	F	G	H
	3	J	K	L	M
	5	N	P	R	S
8	1 3/8	A	B	C	D
	1 3/4	E	F	G	H
	3 1/2	J	K	L	M
	5 1/2	N	P	R	S
10	1 3/4	A	B	C	D
	2	E	F	G	H
	3 1/2	J	K	L	M
	5 1/2	N	P	R	S
12	2	A	B	C	D
	2 1/2	E	F	G	H
	4	J	K	L	M
	5 1/2	N	P	R	S
14	2 1/2	A	B	C	D
	3	E	F	G	H
	4	J	K	L	M
14	5 1/2	N	P	R	S

Type 2 rod end
Short female UN thread

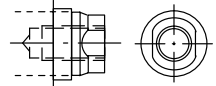

Type 4 rod end
Full male UN thread

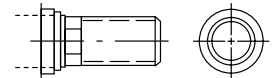

Type 5 rod end
Small male UN thread

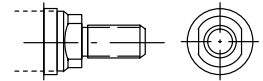

Type 6 rod end
Plain No attachment

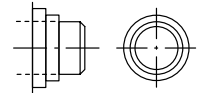

(See detailed rod end information on page 44.)

8 Seal options

Code	Piston Seal	Seal/Scrapper Compound	Ret.
A	U-cups	Nitrile	
B	Cast iron rings	Nitrile	
C	Glass-filled Teflon*	Nitrile	
D	U-cups	Viton-A*	
E	Cast iron rings	Viton-A	
F	Glass-filled Teflon	Viton-A	
K	U-cups	Viton-A/Nitrile	
L	Cast iron rings	Viton-A/Nitrile	
M	Glass-filled Teflon	Viton-A/Nitrile	

(See detailed information on page 46.)

*Teflon and Viton are registered trademarks of E. I. DuPont Co.

9 Port type and size

Code	Type
1	NPTF
2	Oversize NPTF
3	SAE/UN O-ring
4	Oversize SAE/UN
5	NFPA standard SAE/UN

(See detailed information on page 45.)

TE 01 E A C A 3 A A 108 00

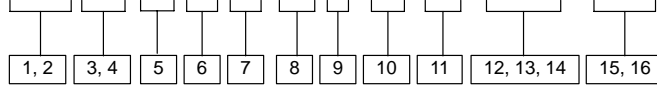

10 Port location

Ports are located as shown below when viewing cylinder from head end (mounting end of double rod cylinder). With some mounting styles, certain port locations cannot be selected due to interference with the mounting.

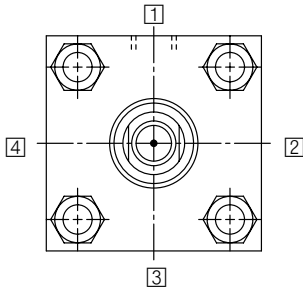

Code	Head	Cap
A-	1	1
B-	1	2
C-	1	3
D-	1	4
E-	2	1
F-	2	2
G-	2	3
H-	2	4
J-	3	1
K-	3	2
L-	3	3
M-	3	4
N-	4	1
P-	4	2
R-	4	3
S-	4	4

11 Limit switch / proximity switch position and type:

Positions are numbered as shown in item 10 at left. "-" in table indicates no switch.

Code	Head	Cap	Switch Type
A-	-	-	none req'd
B-	1	-	01
C-	2	-	01
D-	3	-	01
E-	4	-	01
F-	1	1	01
G-	2	2	01
H-	3	3	01
J-	4	4	01
K-	-	1	01
L-	-	2	01
M-	-	3	01
N-	-	4	01
P-	1	-	PS200
R-	2	-	PS200
S-	3	-	PS200
T-	4	-	PS200
U-	1	1	PS200
V-	2	2	PS200
W-	3	3	PS200
Y-	4	4	PS200
1-	-	1	PS200
2-	-	2	PS200
3-	-	3	PS200
4-	-	4	PS200
5-	1	1	03
6-	2	2	03
7-	3	3	03
8-	4	4	03

(See detailed information on pages 47-49.)

12, 13, 14 Cylinder stroke

Items 12,13 indicate total stroke length from 00 inches to 99 inches. Item 14 indicates fractions of an inch per the following codes:

Code	Fraction	Code	Fraction
0-	0	8-	1/2
1-	1/16	9-	9/16
2-	1/8	A-	5/8
3-	3/16	B-	11/16
4-	1/4	C-	3/4
5-	5/16	D-	13/16
6-	3/8	E-	7/8
7-	7/16	F-	15/16

15, 16 Extra rod projection

Item 15 indicates inches from 0 through 9. Item 16 indicates fractions of an inch per codes shown for item 14 above.

Mounting Styles

Selecting the Proper Mounting

Just as the cylinder bore must be sized to provide the proper force for an application, a cylinder mounting that can absorb these application forces must also be specified. All mounts are designed to absorb the full rated force of the cylinder when properly applied. For applications where the motion is linear and parallel to the cylinder rod motion, a rigid mount is recommended. For curvilinear motion, a swivel mount should be chosen. The specifics of each application dictate the correct mounting style.

Available Mountings

The variety of standard ANSI and NFPA mountings available gives you a broad selection to match the proper mount to your application. Vickers offers rigid mounts (including side lug, flange, and extended tie rod) and swivel mounts (including clevis and trunnion). A guide to proper mount selection is provided on pages 10 through 15. For custom mounts, enter "XX" for model code items 3 and 4 and give a detailed description with drawings. Series TE/TF/TL cylinders are available in all mounting styles listed.

Mounting Styles

Code 01
Side lug
ANSI MS2

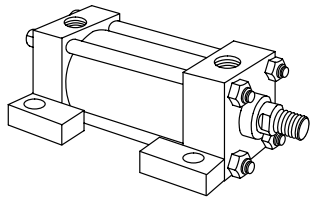

Code 02
Tapped
ANSI MS4

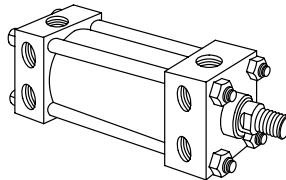

Code 04
Keyed side lug

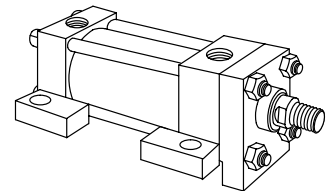

Code 05
Keyed tapped

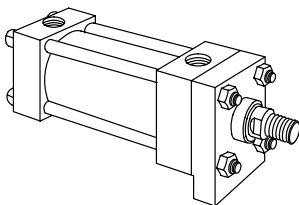

Code 07
Head rectangular flange
ANSI MF1 & ME3

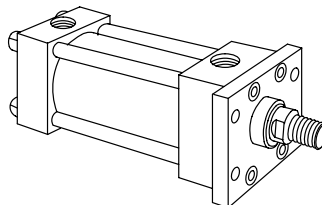

Code 08
Rod end square flanged
ANSI MF5

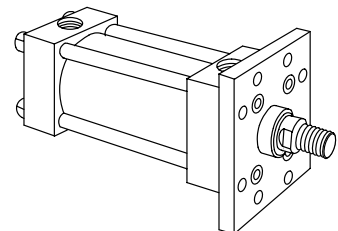

Code 10
Cap clevis
ANSI MP1

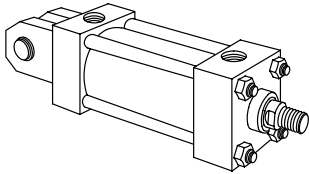

Code 11
Spherical bearing

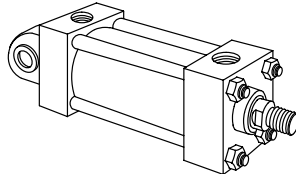

Code 12
Cap rectangular flange
ANSI MF2 & ME4

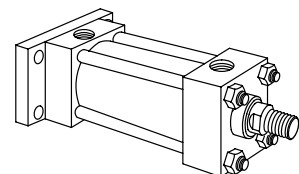

Code 13
Cap square flange
ANSI MF6

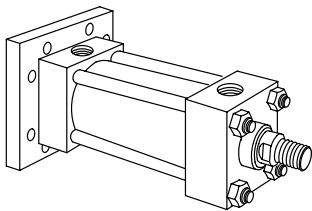

Code 15
Intermediate trunnion
ANSI MT4

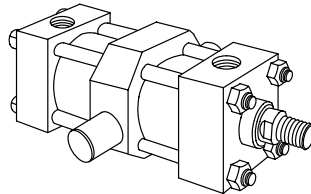

Code 16
Cap trunnion
ANSI MT2

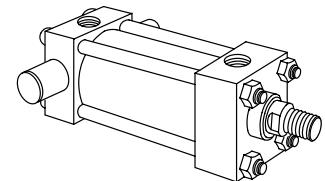

Code 17
Head trunnion
ANSI MT1

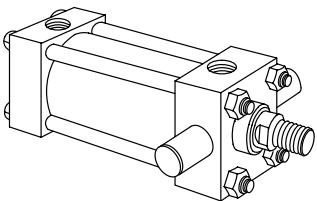

Code 21
Cap extended tie rod
ANSI MX2

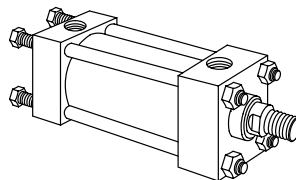

Code 22
Head extended tie rod
ANSI MX3

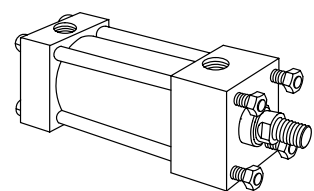

Code 23
Both ends extended tie rod
ANSI MX1

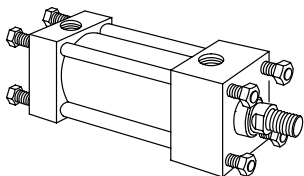

Code 25
Double rod, side lug

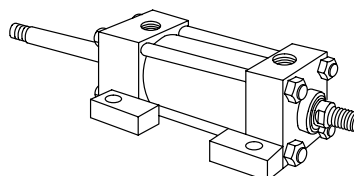

Mounting Styles Not Shown:

Code Mounting style

- 24 – No mount
- 26 – Double rod, tapped
- 28 – Double rod, keyed side lug
- 29 – Double rod, keyed tapped
- 31 – Double rod, rectangular flange
- 32 – Double rod square flange
- 34 – Double rod, intermediate trunnion
- 35 – Double rod, head trunnion
- 39 – Double rod, head end extended tie rod
- 40 – Double rod, both ends extended tie rod
- 41 – Double rod, no mount

Application Guide for Mountings

Code 01 Side Lug (ANSI MS2)

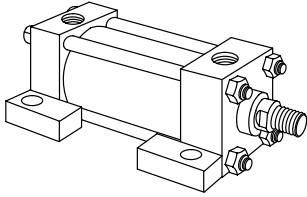

Code 02 Tapped

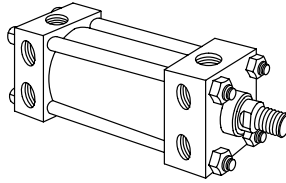

Code 04 Keyed Side Lug

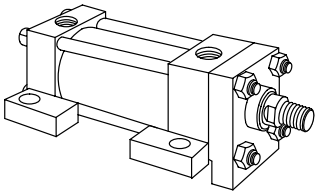

Code 05 Keyed Tapped

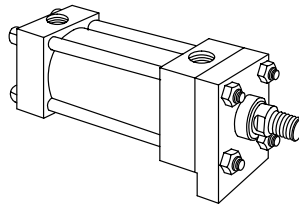

The drawing below shows the modification of a Code 01 mount to convert it to a Code 04. Use drawings for Code 01, pages 16–39, for dimensions not shown.

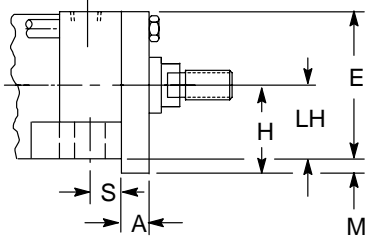

The drawing below shows the modification of a Code 02 mount to convert it to a Code 05. Use drawings for Code 02, pages 16–39, for dimensions not shown.

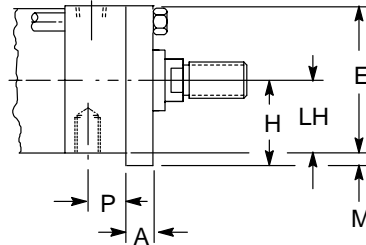

Side lug and tapped mounts are for moving loads along a flat guided surface as in a carriage along rails.

The mounting surface should be flat and parallel to the centerline of the piston rod.

The load should be guided to traverse along the centerline of the piston rod.

The frame on which the cylinder is mounted must be sufficiently rigid to resist bending moments.

With unsupported loads, the bearing must absorb more force. For these applications, the larger available rod is recommended, and stop tubes should be considered.

Use high tensile socket head cap screws or hex head bolts tightened to the manufacturer's recommended torque.

For high shock applications, dowel pins or shear keys should be incorporated in the mounting design. For these applications, consider a keyed side lug mount (04) or keyed tapped mount (05).

For severe side load applications, consult your local Vickers sales engineer.

See individual bore size drawings for maximum allowable pressure ratings.

NOTE

For strokes in excess of 30", see "Stop tube selection" on page 50.

Dimensions in inches

Bore dia.	E	LH	A	H (Ref.)	P	S	M
1 1/2	2.00	.994 .992	.312 .310	1.188	1.000	.438	.188
2	2.50	1.244 1.242	.312 .310	1.438	1.000	.438	.188
2 1/2	3.00	1.494 1.492	.312 .310	1.688	1.000	.438	.188
3 1/4	3.75	1.869 1.867	.562 .560	2.188	1.125	.562	.313
4	4.50	2.244 2.242	.562 .560	2.563	1.125	.563	.313
5	5.50	2.744 2.742	.562 .560	3.063	1.125	.750	.313
6	6.50	3.244 3.242	.687 .685	3.625	1.250	.750	.375

Code 07 Head Rectangular Flange (ANSI MF1 & ME3)

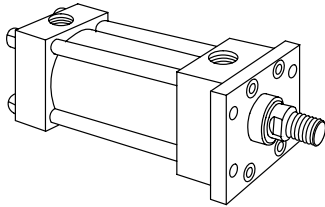

Code 10 Clevis
(ANSI MP1)

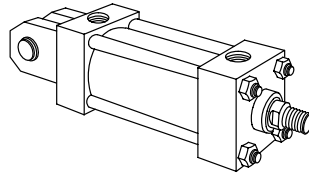

Code 08 Head Square Flange (ANSI MF5)

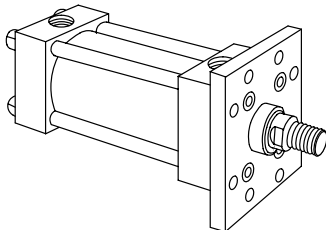

These mounts are ideal for straight line force transfer applications in which the cylinder is used in tension (pulling), as in pull presses. For compression applications (pushing), a cap flange mount is more appropriate.

The mounting surface should be flat, and the rod end bearing should be piloted into it.

The frame on which the cylinder is mounted must be sufficiently rigid to resist bending moments.

The force of the load should be perpendicular to the mounting surface and parallel to the centerline of the piston rod. For eccentric loads, the oversize alternate rod is recommended. Stop tubes should also be considered.

The square flange mount (08) is recommended for heavy duty applications.

Use high tensile socket head cap screws or hex head bolts tightened to the manufacturer's recommended torque.

NOTE

For strokes in excess of 30", see "Stop tube selection" on page 50.

This mount is for applications in which the machine member travels in a curved path within one plane.

This mount can be used both in compression (push) and tension (pull). Care must be exercised to prevent rod buckling in compression applications with long strokes. See pages 57 and 58 for stroke limitations.

The centerline of the machine member that attaches to the swivel pin must be perpendicular to the centerline of the piston rod and the curved path must be in one plane only. Any misalignment will cause excessive side loading on the bearing and piston. This will lead to premature failure. For applications with small amounts of misalignment, consider the spherical bearing mount (11).

NOTE

For strokes in excess of 24", see "Stop tube selection" on page 50.

Application Guide for Mountings

Code 11 Spherical Bearing

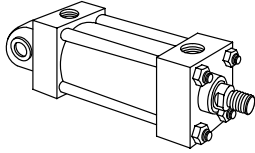

This mount is for applications in which the machine member travels in a curved path in one plane where some misalignment is unavoidable. The amount of allowable misalignment can be calculated.

This mount can be used both in compression (push) and tension (pull) applications. Care must be exercised to prevent rod buckling in compression applications with long strokes. See pages 55 through 58 for stroke limitations.

Maximum radial static and dynamic bearing loads must not exceed the recommended ratings shown in the following table.

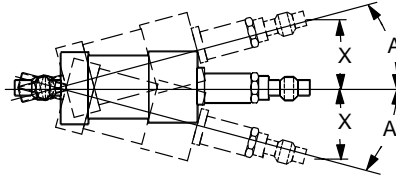

Angle A is the recommended maximum angle of misalignment.

To find the maximum recommended X distance, multiply the distance between pivot mounting holes (see bore size drawing) by the tangent of angle A.

NOTE

For strokes in excess of 24", see "Stop tube selection" on page 50.

Bore	Rod dia.	Pin dia.	Angle A	Tangent of A	Static load ratings	
					Radial	Thrust
1 1/2	5/8	1/2	1.5	.026	8100	3200
2	5/8	1/2	1.5	.026	8100	3200
2 1/2	5/8	1/2	1.5	.026	8100	3200
3 1/4	3/4	3/4	2	.035	18,800	7500
4	1	3/4	2	.035	18,800	7500
5	1	3/4	2	.035	18,800	7500
6	1 3/8	1	2	.035	33,300	13,300
7	1 3/8	1	2	.035	33,300	13,300
8	1 3/8	1	2	.035	33,300	13,300
10	1 3/4	1 3/8	2	.035	59,800	24,000
12	2	1 3/4	2.5	.044	102,000	40,700
14	2 1/2	2	2.5	.044	132,000	53,000

Code 12 Cap Rectangular Flange
(ANSI MF2 & ME4)

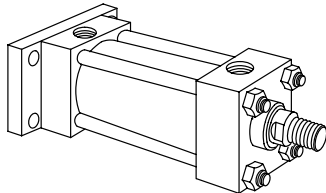

Code 13 Cap Square Flange
(ANSI MF6)

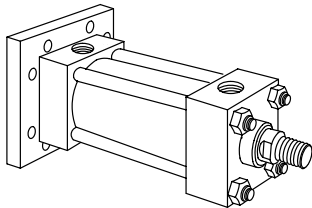

These mounts are for straight line force transfer applications in which the cylinder is used in compression (pushing) applications.

For tension applications (pulling), a head flange mount is recommended.

The mounting surface should be flat and perpendicular to the force of the load.

The frame on which the cylinder is mounted must be sufficiently rigid to resist bending moments.

The force of the load should be perpendicular to the mounting surface and parallel to the centerline of the piston rod. For eccentric loads, the oversize alternate rod is recommended. Stop tubes should also be considered.

The cap square flange mount (code 13) is recommended for heavy duty applications.

Use high tensile socket head cap screws or hex head bolts tightened to the manufacturer's recommended torque value.

NOTE

For strokes in excess of 30", see "Stop tube selection" on page 50.

Code 15 Intermediate Trunnion
(ANSI MT4)

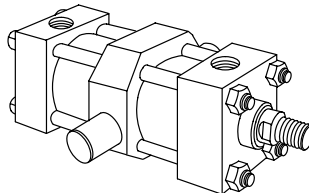

The Intermediate Trunnion mount is for longer stroke applications in which the machine member travels in a curved path in one plane.

On special orders, the trunnion can be located anywhere along the body.

This mount can be used both in compression (push) and tension (pull) applications.

It is recommended that rigidly mounted pillow blocks with bearings at least as long as the trunnion pins be used. The pillow blocks should be installed as close to the shoulder of the trunnion as possible.

NOTE

For strokes in excess of 24", see "Stop tube selection" on page 50.

Code 16 Cap Trunnion
(ANSI MT2)

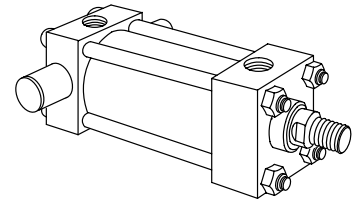

Cap Trunnion mounts are for applications in which the machine member travels in a curved path in one plane, and can be used both in compression (push) and tension (pull) applications. When used in compression applications, head trunnion mounts provide a longer maximum stroke than cap trunnion mounts.

The trunnion pins are an integral part of the cap and can be sleeved to provide an extremely tight fit to the mating machine member and permit curvilinear motion.

It is recommended that rigidly mounted pillow blocks with bearings at least as long as the trunnion pins be used. The pillow blocks should be installed as close to the shoulder of the trunnion as possible.

NOTE

For strokes in excess of 24", see "Stop tube selection" on page 50.

Application Guide for Mountings

Code 17 Head Trunnion (ANSI MT1)

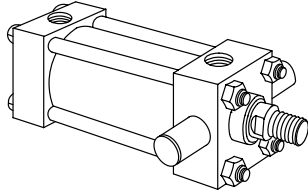

Head Trunnion mounts are for applications in which the machine member travels in a curved path in one plane.

Either mount can be used both in compression (push) and tension (pull) applications. When used in compression applications, head trunnion mounts provide a longer maximum stroke than cap trunnion mounts.

The trunnion pins are an integral part of the head and can be sleeved to provide an extremely tight fit to the mating machine member and permit curvilinear motion.

It is recommended that rigidly mounted pillow blocks with bearings at least as long as the trunnion pins be used. The pillow blocks should be installed as close to the shoulder of the trunnion as possible.

NOTE

For strokes in excess of 24", see "Stop tube selection" on page 50.

Code 21 Cap Extended Tie Rod (ANSI MX2)

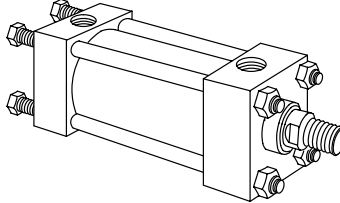

These mounts are for straight line force transfer applications. The cap extended tie rod mount is recommended for compression (pushing) applications.

The mounting surface should be flat and the frame on which the cylinder is mounted must be sufficiently rigid to resist bending moments.

Once fitted into the application framework, the nuts which are provided should be torqued to the values listed in the table below.

Tie Rod Diameters & Torque Values

Diameters and torque values in the following table apply to all mounting styles.

Bore dia. (inch)	Tie rods	
	Dia. (inch)	Torque (ft. lbs.)
1 1/2	1/4	8
2, 2 1/2	5/16	16
3 1/4, 4	3/8	28
5, 6, 7, 8	1/2	66
10, 12	5/8	150
14	3/4	225

Bearing retainer screw torque

Screw size (inch)	Torque (ft. lbs.)
.2500-28	7
.3125-24	12
.3750-24	22
.5000-20	50

NOTE

For strokes in excess of 30" see "Stop tube selection" on page 50.

Code 22 Head Extended Tie Rod (ANSI MX3)

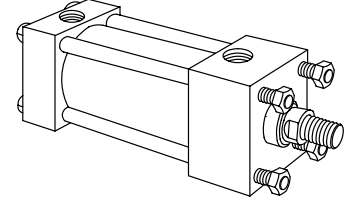

These mounts are for straight line force transfer applications. The head extended tie rod mount is recommended for tension (pulling) applications.

The mounting surface should be flat and the frame on which the cylinder is mounted must be sufficiently rigid to resist bending moments.

On head mount applications, the cartridge provides a pilot diameter to align the rod in the mounting frame.

Once fitted into the application framework, the nuts which are provided should be torqued to the values listed in the table on the previous page.

The force on the rod should be perpendicular to the mounting surface and coincide with the centerline of the piston rod. For eccentric loads, the larger of the two available rods in each bore size is recommended. Stop tubes should also be considered.

NOTE

For strokes in excess of 30", see "Stop tube selection" on page 50.

**Code 23 Both Ends
Extended Tie Rod (ANSI MX1)**

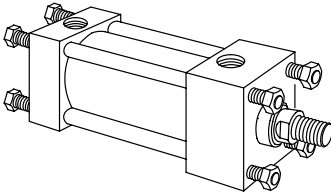

These mounts are for straight line force transfer applications. Both ends extended tie rod mounts are suited for tension and compression applications or applications where additional hardware is to be attached to cylinders.

The mounting surface should be flat and the frame on which the cylinder is mounted must be sufficiently rigid to resist bending moments.

Once fitted into the application framework, the nuts which are provided should be torqued to the values listed in the table on page 14.

The force on the rod should be perpendicular to the mounting surface and coincide with the centerline of the piston rod. For eccentric loads, the larger of the two available rods in each bore size is recommended. Stop tubes should also be considered.

NOTE

For strokes in excess of 30", see "Stop tube selection" on page 50.

**Code 25 Double Rod,
Side Lug (ANSI MX1)**

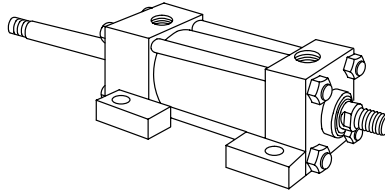

Double rod cylinders are specified when equal displacement is desired on both sides of the piston, or when the application is such that another function can be performed simultaneously with a second rod.

The single rod mount application data is also applicable to double rod cylinders.

In addition to the side lug mount illustrated above, the following mounts are also available for double rod end cylinders.

Code 26 Double Rod, Tapped

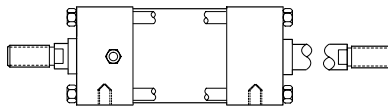

**Code 31 Double Rod,
Rectangular Flange and
Code 32 Double Rod,
Square Flange**

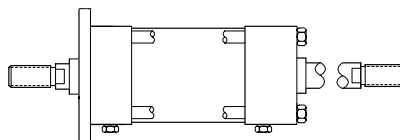

**Code 34 Double Rod,
Intermediate Trunnion**

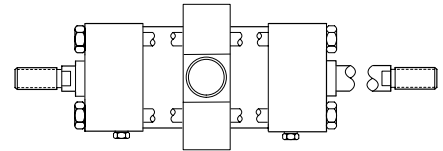

**Code 35 Double Rod,
Head Trunnion**

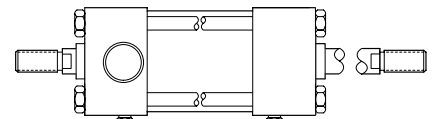

**Code 39 Double Rod, Head
Extended Tie Rod**

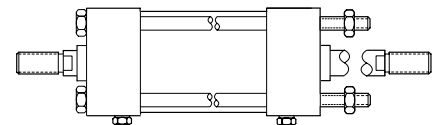

**Code 40 Double Rod, Both Ends
Extended Tie Rod**

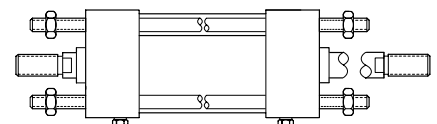

1 1/2 inch Cylinder Bore

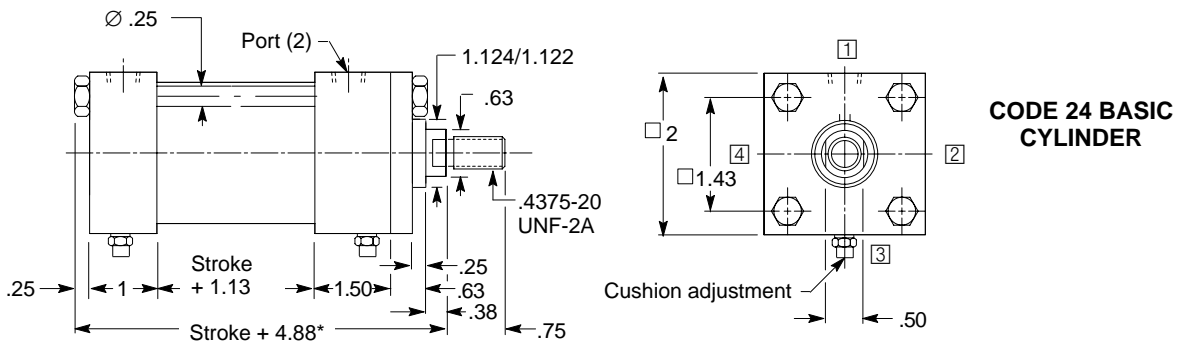

ALTERNATE ROD SIZES AVAILABLE (in inches)	ROD DIA. MM	DIMENSIONAL CHANGES THAT OCCUR AS ROD DIAMETER IS CHANGED Add "N" to all dimensions marked with *.							
		N*	A	B	C	D	VB	V	KK thd.
1	.38	1.13	1.499/ 1.497	.50	.88	.88	.50	.750-16 UNF-2A	

CODE 25 DOUBLE ROD SIDE LUG MOUNT

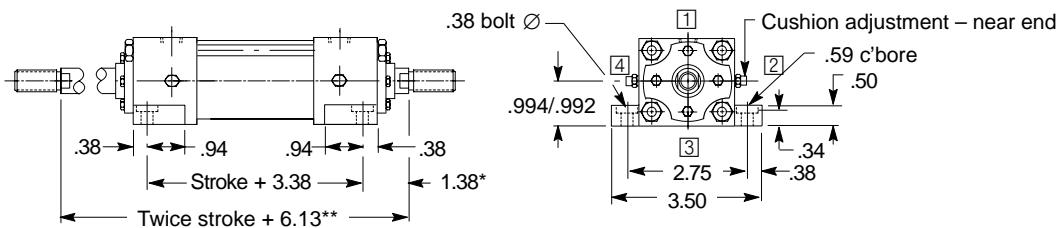

CODE 01 SIDE LUG MOUNT

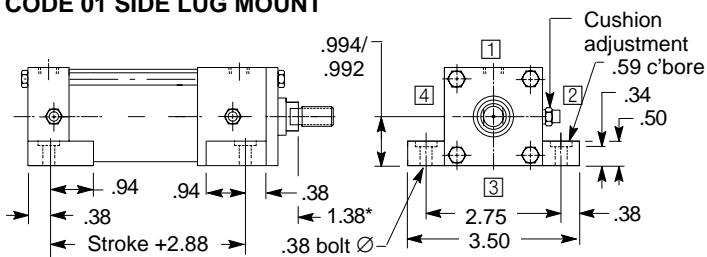

CODE 02 TAPPED MOUNT

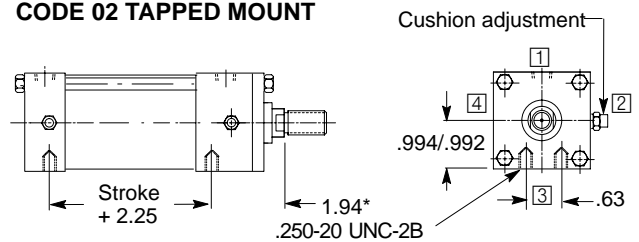

CODE 07 HEAD RECTANGULAR FLANGE MOUNT †

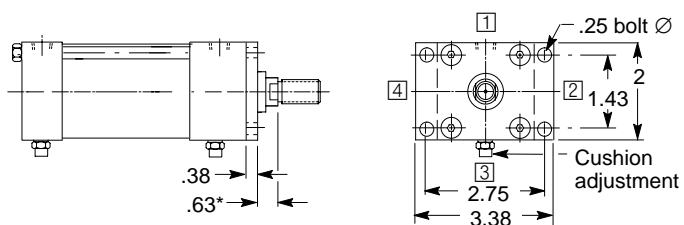

CODE 08 HEAD SQUARE FLANGE MOUNT

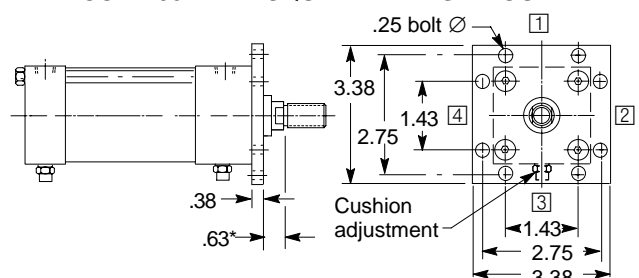

†Maximum working pressure 800 PSI (for minimum flange deflection)

CODE 10 CLEVIS MOUNT

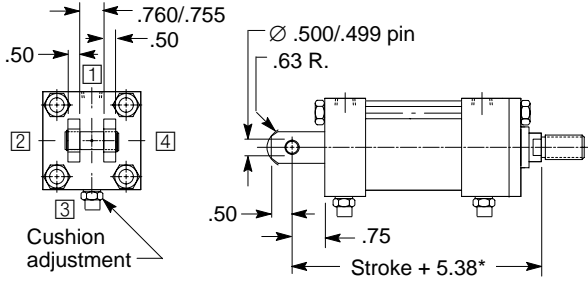

CODE 11 SPHERICAL BEARING MOUNT

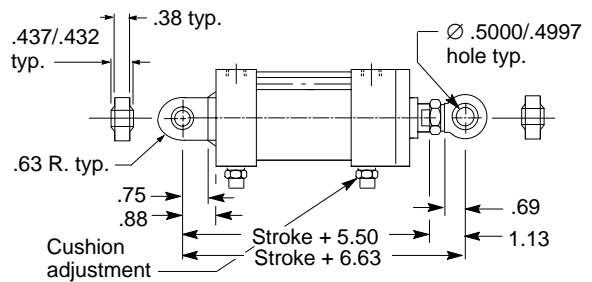

CODE 12 CAP RECTANGULAR FLANGE MOUNT†

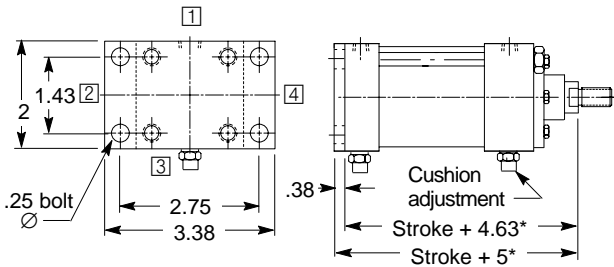

CODE 13 CAP SQUARE FLANGE MOUNT

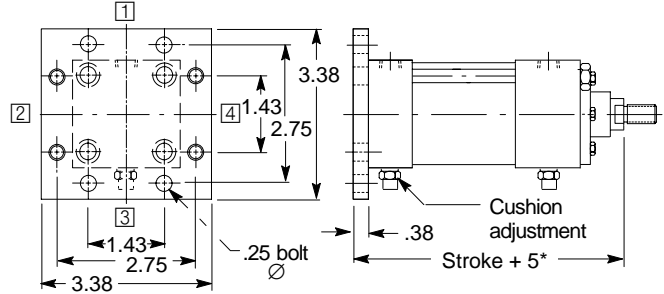

CODE 15 INTERMEDIATE TRUNNION MOUNT

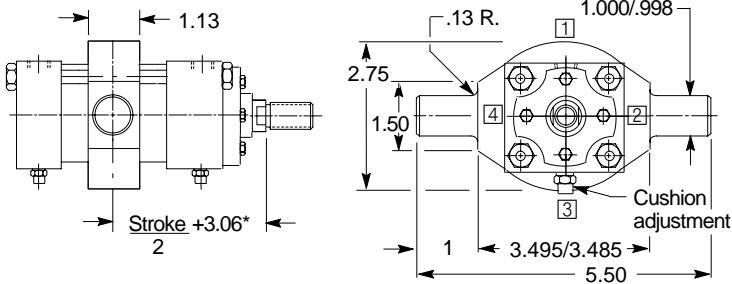

CODE 16 CAP TRUNNION MOUNT

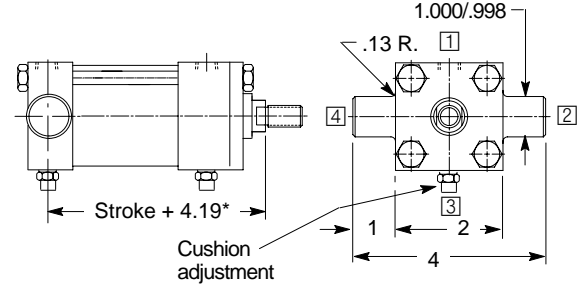

CODE 17 HEAD TRUNNION MOUNT

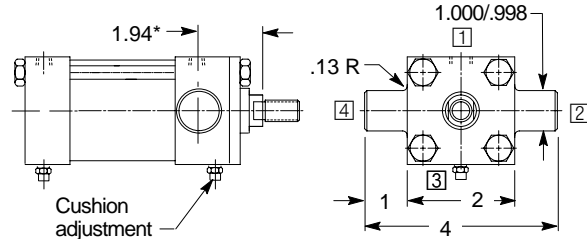

CODE 21 CAP EXTENDED TIE ROD MOUNT

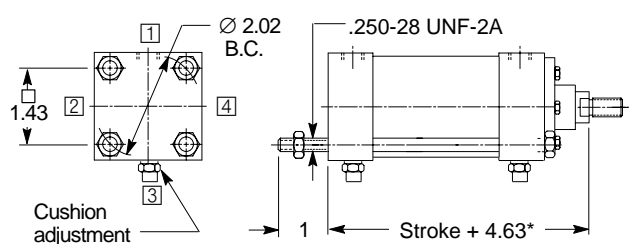

CODE 22 HEAD EXTENDED TIE ROD MOUNT

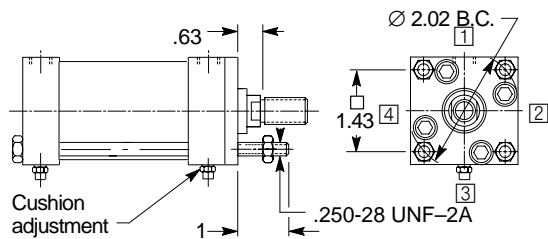

CODE 23 BOTH ENDS EXTENDED TIE ROD MOUNT

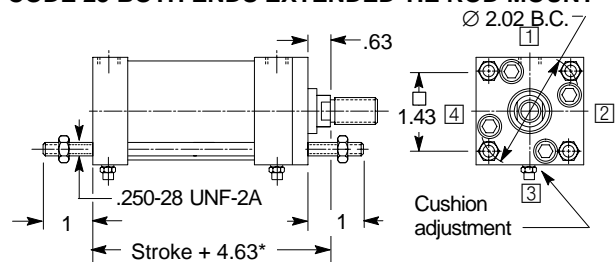

†Maximum working pressure 800 PSI (for minimum flange deflection)

2 inch Cylinder Bore

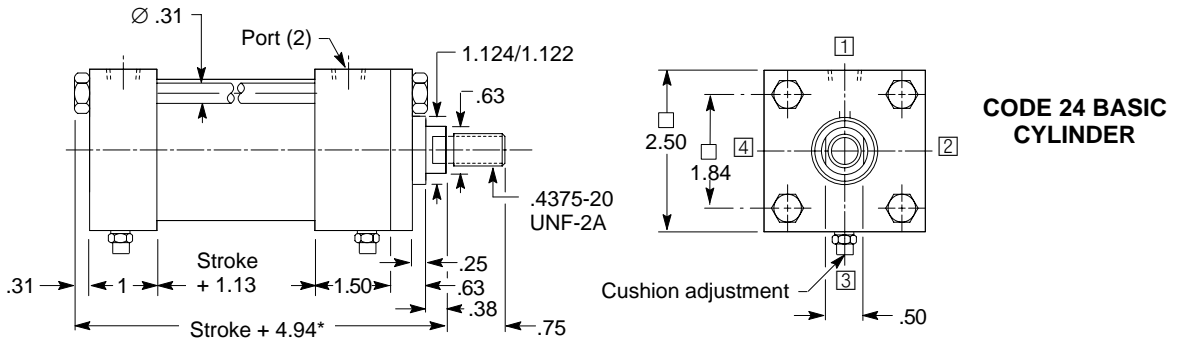

ALTERNATE ROD SIZES AVAILABLE (in inches)	ROD DIA. MM	DIMENSIONAL CHANGES THAT OCCUR AS ROD DIAMETER IS CHANGED								
		Add "N" to all dimensions marked with *.								
		N*	A	B	C	D	VB	V	KK thd.	
1	.38	1.13	1.499/ 1.497	.50	.88	.88	.50	.750-16 UNF-2A		
1 3/8	.63	1.63	1.999/ 1.997	.63	1.13	1	.63	1.000-14 UNS-2A		

CODE 25 DOUBLE ROD SIDE LUG MOUNT

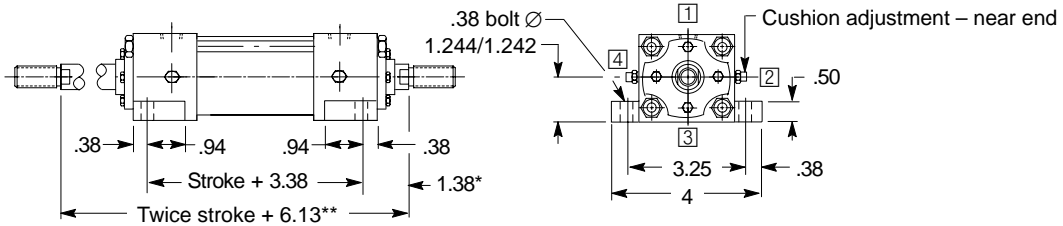

CODE 01 SIDE LUG MOUNT

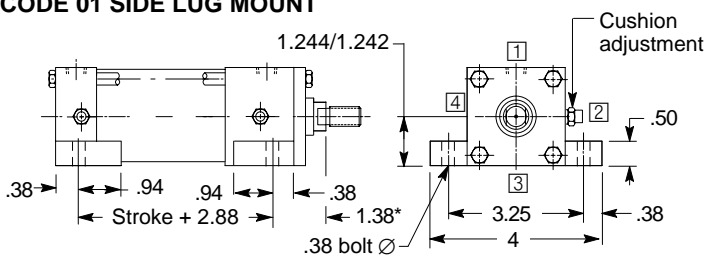

CODE 02 TAPPED MOUNT

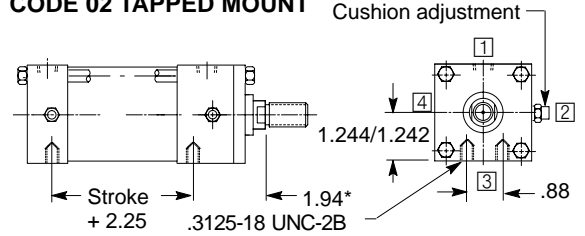

CODE 07 HEAD RECTANGULAR FLANGE MOUNT †

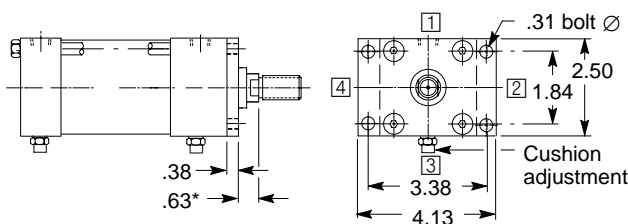

CODE 08 HEAD SQUARE FLANGE MOUNT

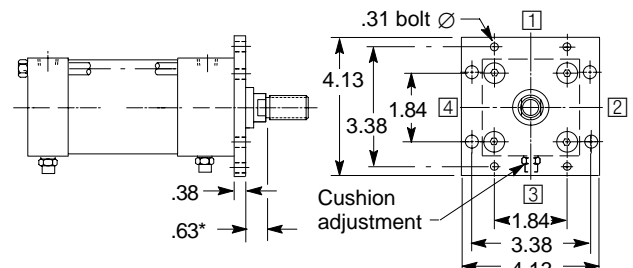

†Maximum working pressure 800 PSI (for minimum flange deflection)

CODE 10 CLEVIS MOUNT

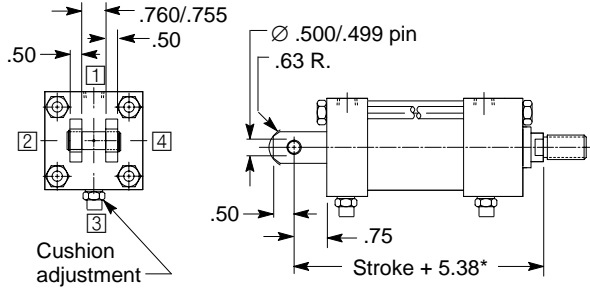

CODE 11 SPHERICAL BEARING MOUNT

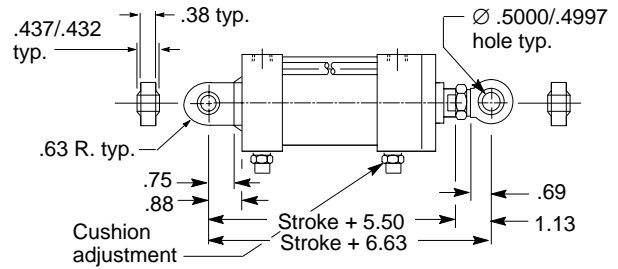

CODE 12 CAP RECTANGULAR FLANGE MOUNT†

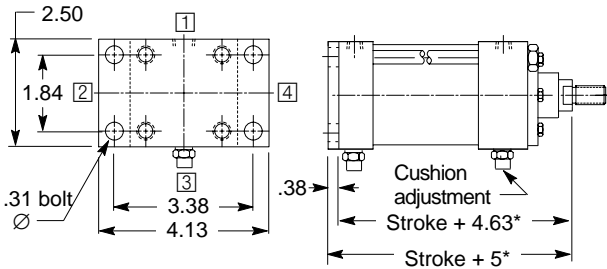

CODE 13 CAP SQUARE FLANGE MOUNT

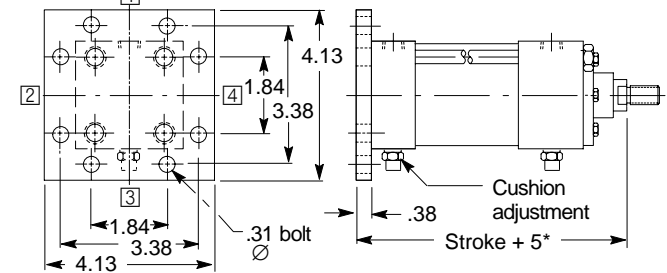

CODE 15 INTERMEDIATE TRUNNION MOUNT

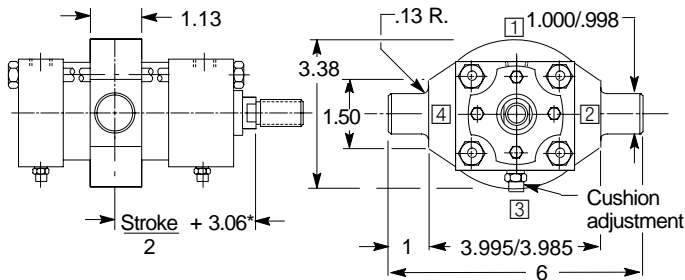

CODE 16 CAP TRUNNION MOUNT

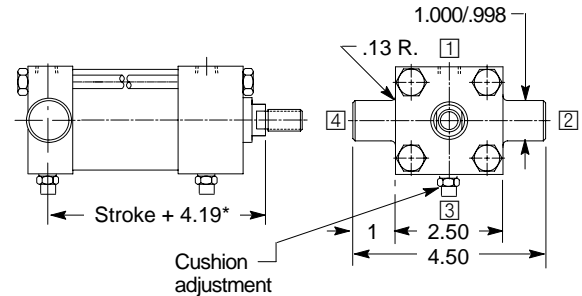

CODE 17 HEAD TRUNNION MOUNT

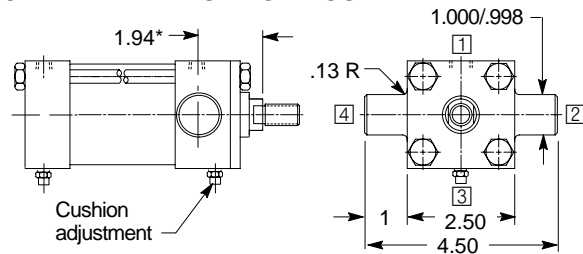

CODE 21 CAP EXTENDED TIE ROD MOUNT

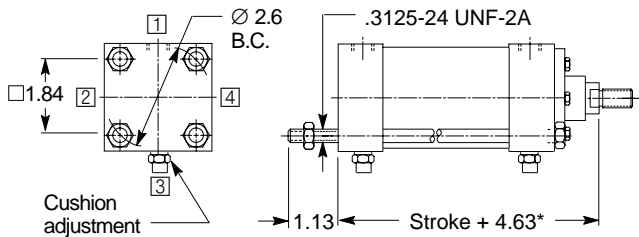

CODE 22 HEAD EXTENDED TIE ROD MOUNT

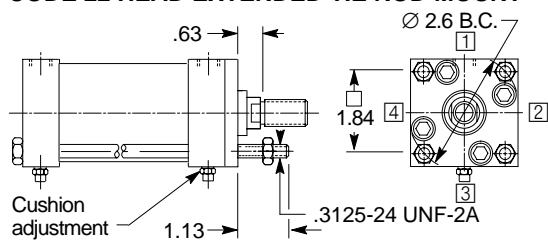

CODE 23 BOTH ENDS EXTENDED TIE ROD MOUNT

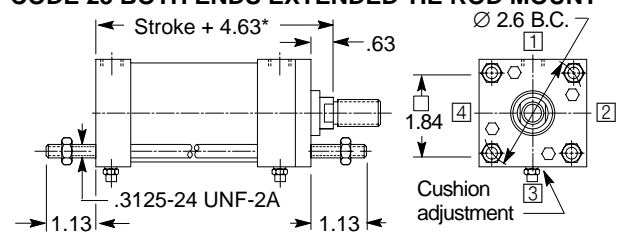

†Maximum working pressure 800 PSI (for minimum flange deflection)

2 1/2 inch Cylinder Bore

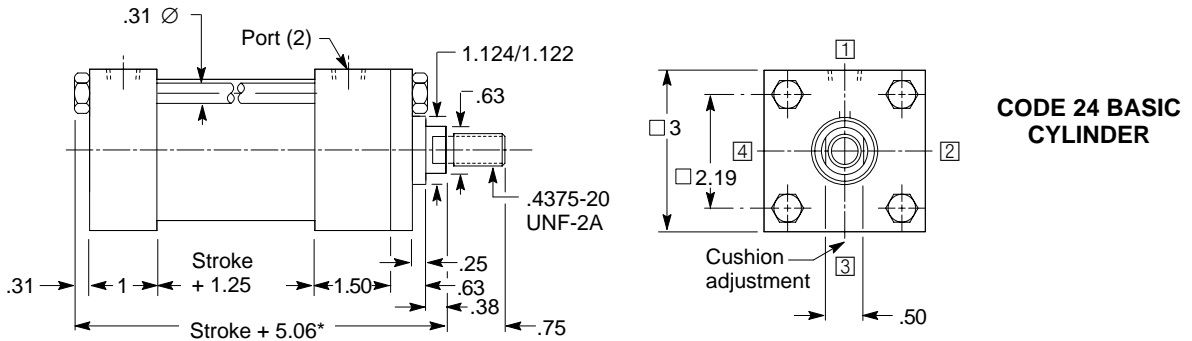

ALTERNATE ROD SIZES AVAILABLE (in inches)	ROD DIA. MM	DIMENSIONAL CHANGES THAT OCCUR AS ROD DIAMETER IS CHANGED							KK thd.	
		N*	A	B	C	D	VB	V		
1	.38	1.13	1.499/1.497	.50	.88	.88	.50	.750-16 UNF-2A		
1.38	.63	1.63	1.999/1.997	.63	1.13	1	.63	1.000-14 UNS-2A		
1.75	.88	2	2.374/2.372	.75	1.50	1.13	.75	1.250-12 UNF-2A		

CODE 25 DOUBLE ROD SIDE LUG MOUNT

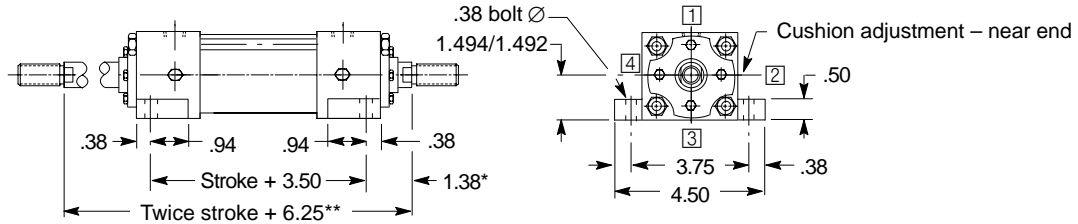

CODE 01 SIDE LUG MOUNT

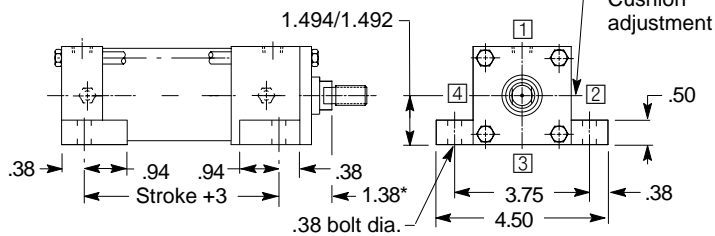

CODE 02 TAPPED MOUNT

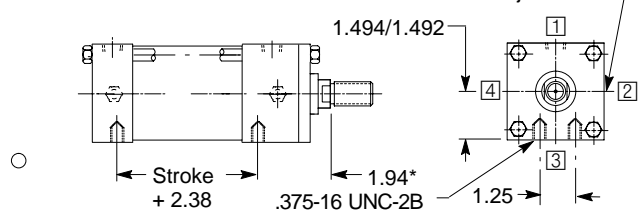

CODE 07 HEAD RECTANGULAR FLANGE MOUNT †

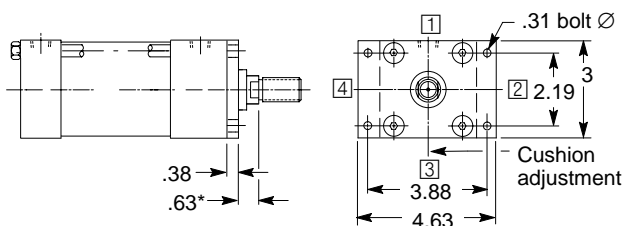

CODE 08 HEAD SQUARE FLANGE MOUNT

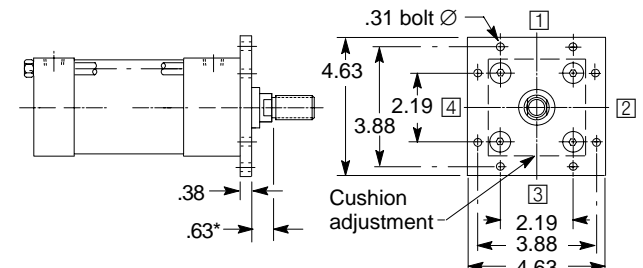

†Maximum working pressure 800 PSI (for minimum flange deflection)

CODE 10 CLEVIS MOUNT

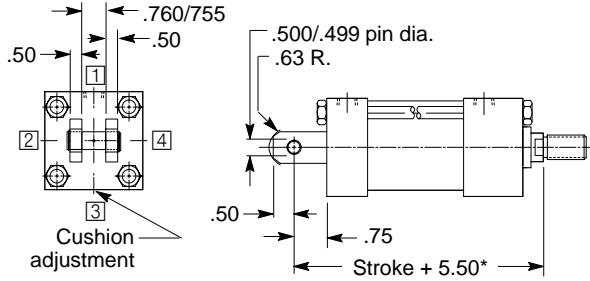

CODE 11 SPHERICAL BEARING MOUNT

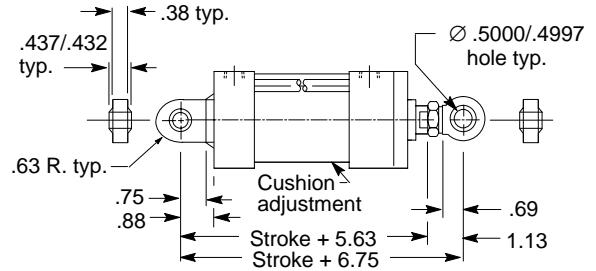

CODE 12 CAP RECTANGULAR FLANGE MOUNT†

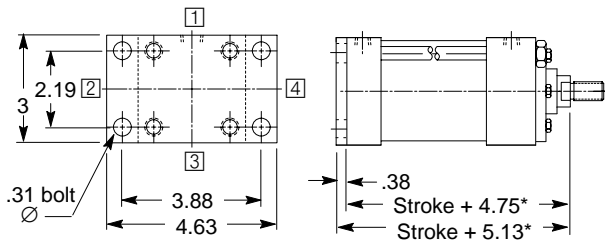

CODE 13 CAP SQUARE FLANGE MOUNT

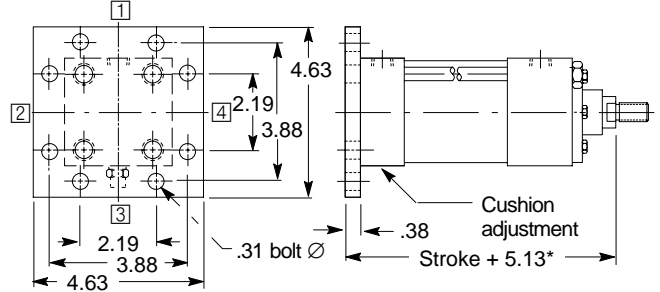

CODE 15 INTERMEDIATE TRUNNION MOUNT

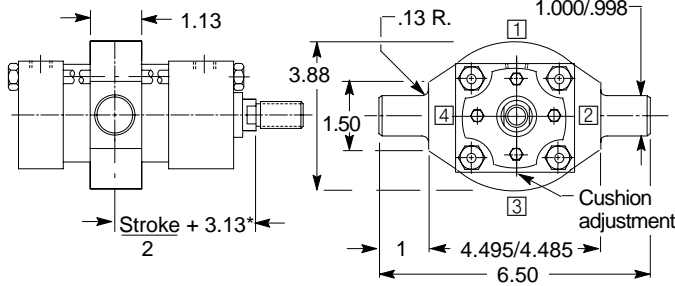

CODE 16 CAP TRUNNION MOUNT

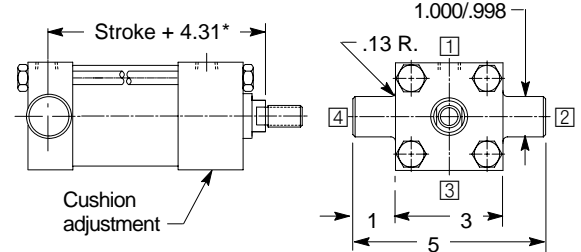

CODE 17 HEAD TRUNNION MOUNT

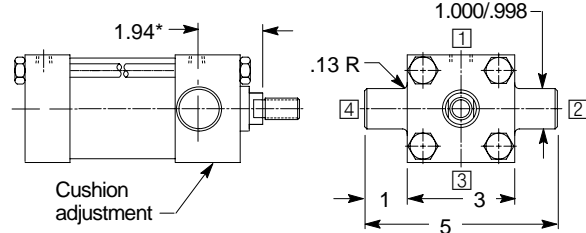

CODE 21 CAP EXTENDED TIE ROD MOUNT

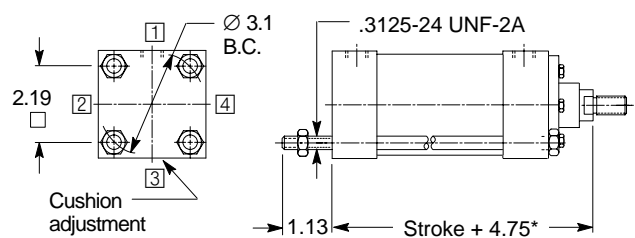

CODE 22 HEAD EXTENDED TIE ROD MOUNT

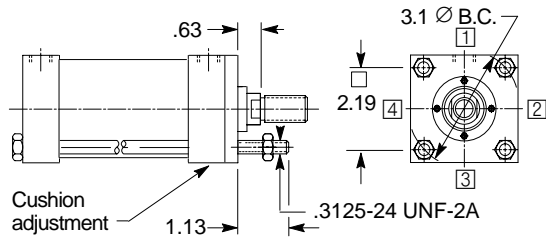

CODE 23 BOTH ENDS EXTENDED TIE ROD MOUNT

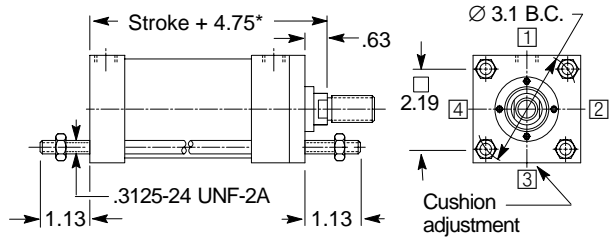

†Maximum working pressure 800 PSI (for minimum flange deflection)

3 1/4 inch Cylinder Bore

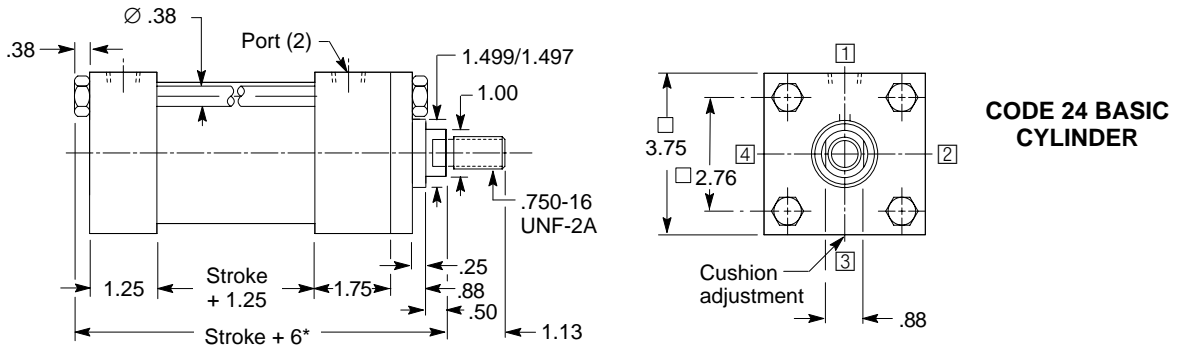

ALTERNATE ROD SIZES AVAILABLE (in inches)	ROD DIA. MM	DIMENSIONAL CHANGES THAT OCCUR AS ROD DIAMETER IS CHANGED Add "N" to all dimensions marked with *.							KK thd.	
		N*	A	B	C	D	VB	V		
1 3/8	.25	1.63	1.999/ 1.997	.63	1.13	1	.38	1.000-14 UNS-2A		
1 3/4	.50	2	2.374/ 2.372	.75	1.50	1.13	.50	1.250-12 UNF-2A		
2	.63	2.25	2.624/ 2.622	.88	1.69	1.13	.50	1.500-16 UNF-2A		

CODE 25 DOUBLE ROD SIDE LUG MOUNT

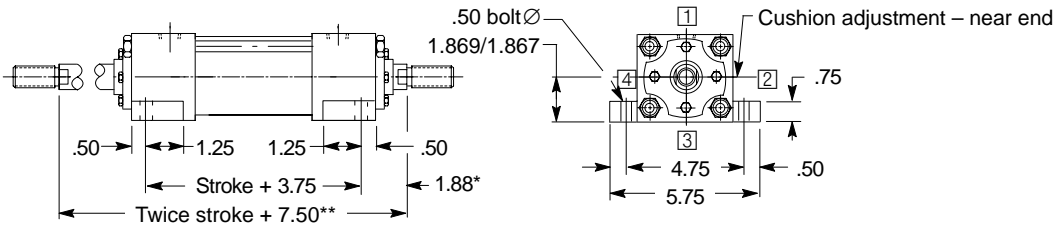

CODE 01 SIDE LUG MOUNT

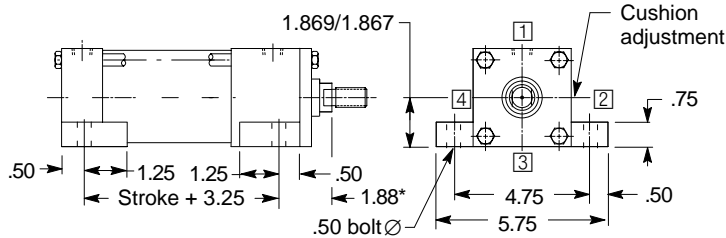

CODE 02 TAPPED MOUNT

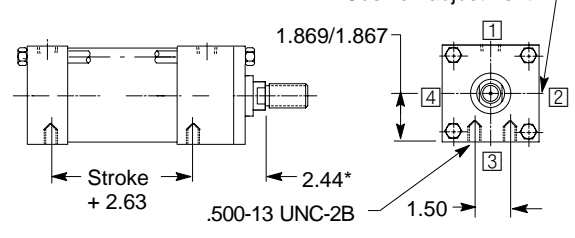

CODE 07 HEAD RECTANGULAR FLANGE MOUNT †

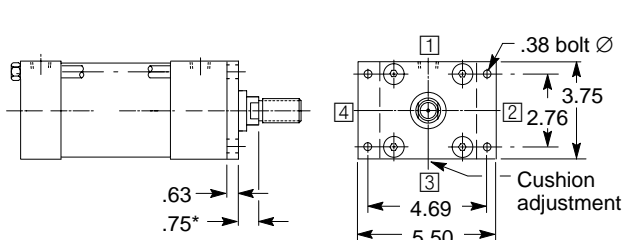

CODE 08 HEAD SQUARE FLANGE MOUNT

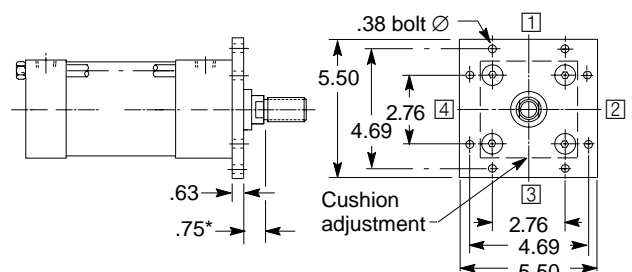

†Maximum working pressure 800 PSI (for minimum flange deflection)

CODE 10 CLEVIS MOUNT

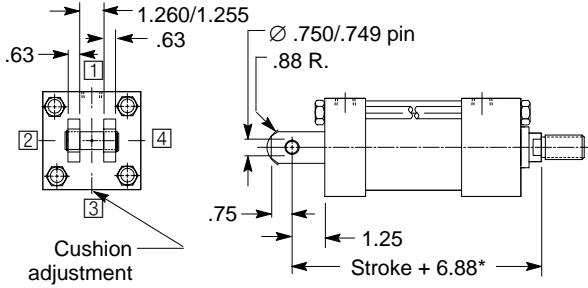

CODE 11 SPHERICAL BEARING MOUNT

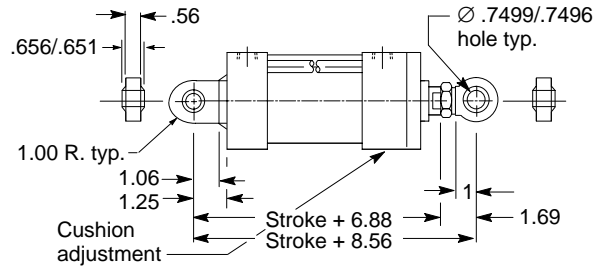

CODE 12 CAP RECTANGULAR FLANGE MOUNT†

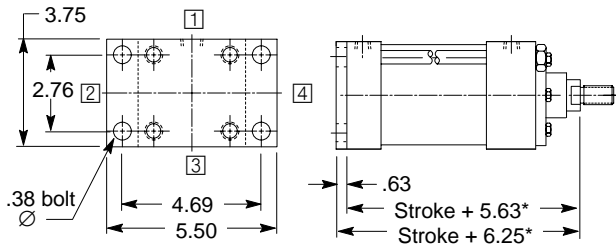

CODE 13 CAP SQUARE FLANGE MOUNT

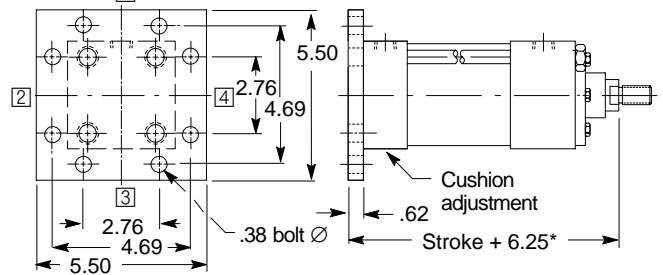

CODE 15 INTERMEDIATE TRUNNION MOUNT

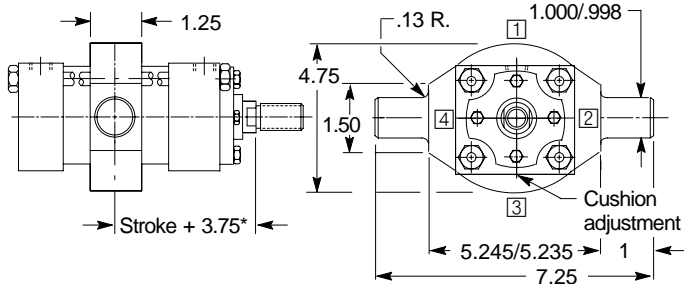

CODE 16 CAP TRUNNION MOUNT

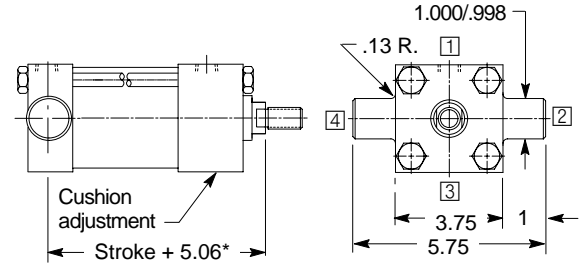

CODE 17 HEAD TRUNNION MOUNT

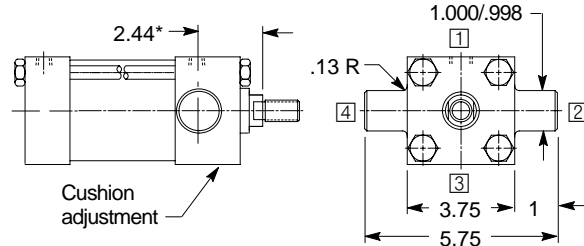

CODE 21 CAP EXTENDED TIE ROD MOUNT

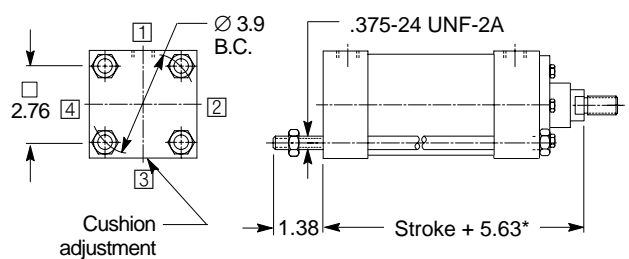

CODE 22 HEAD EXTENDED TIE ROD MOUNT

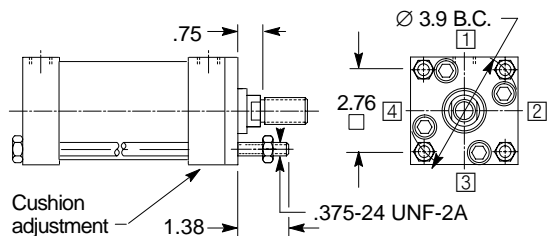

CODE 23 BOTH ENDS EXTENDED TIE ROD MOUNT

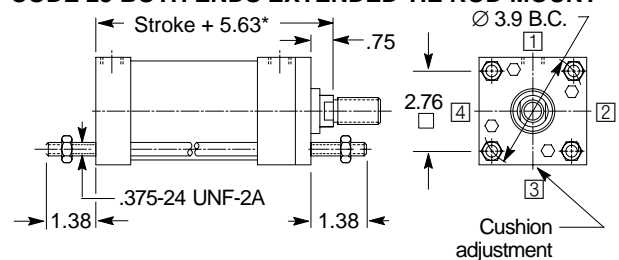

†Maximum working pressure 800 PSI (for minimum flange deflection)

4 inch Cylinder Bore

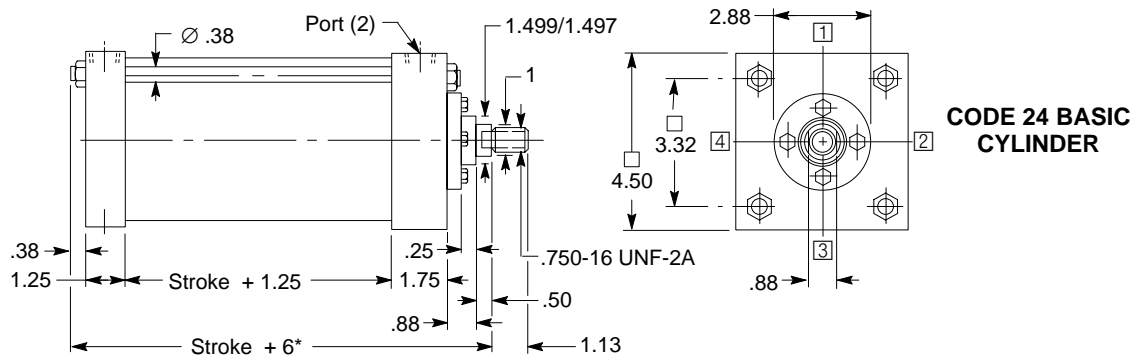

ALTERNATE ROD SIZES AVAILABLE (in inches)	ROD DIA. MM	DIMENSIONAL CHANGES THAT OCCUR AS ROD DIAMETER IS CHANGED								
		N*	A	B	C	D	RD	VB	V	
1 3/8	.25	1.63	1.999/ 1.997	.63	1.13	3.38	1	.38	1.000-14 UNS-2A	
1 3/4	.50	2	2.374/ 2.372	.75	1.50	3.38	1.13	.50	1.250-12 UNF-2A	
2	.63	2.25	2.624/ 2.622	.88	1.69	3.50	1.13	.50	1.500-12 UNF-2A	
2 1/2	.88	3	3.124/ 3.122	1	2.06	4	1.25	.63	1.875-12 UN-2A	

CODE 25 DOUBLE ROD SIDE LUG MOUNT

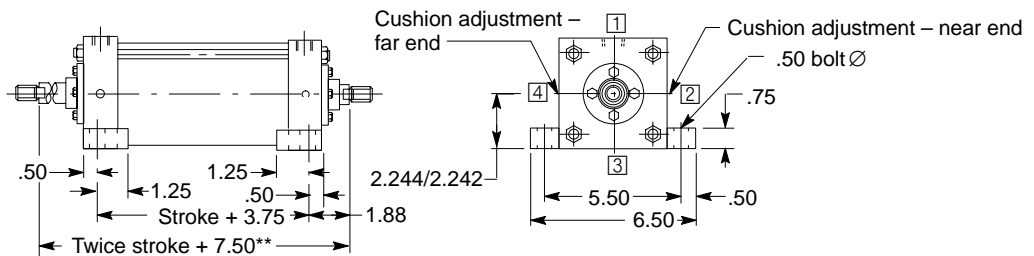

CODE 01 SIDE LUG MOUNT

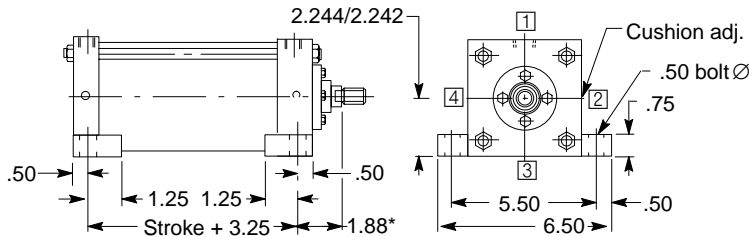

CODE 02 TAPPED MOUNT

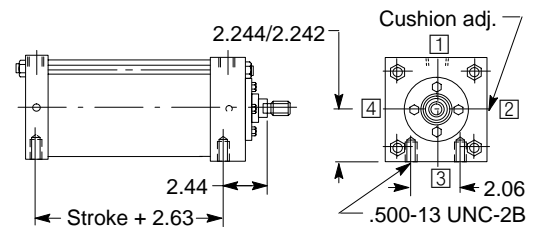

CODE 07 HEAD RECTANGULAR FLANGE MOUNT †

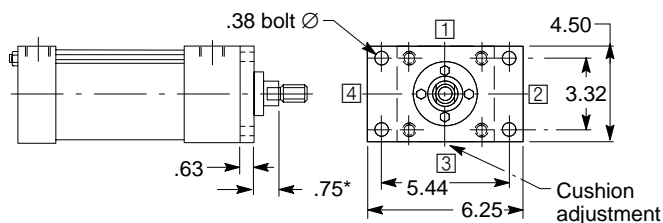

CODE 08 HEAD SQUARE FLANGE MOUNT

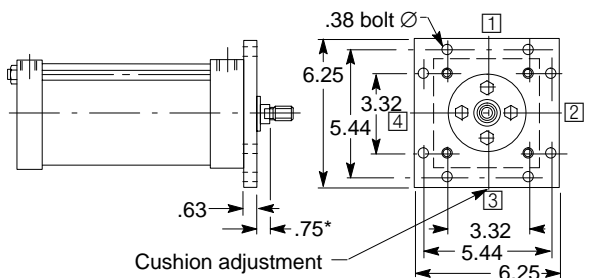

†Maximum working pressure 800 PSI (for minimum flange deflection)

CODE 10 CLEVIS MOUNT

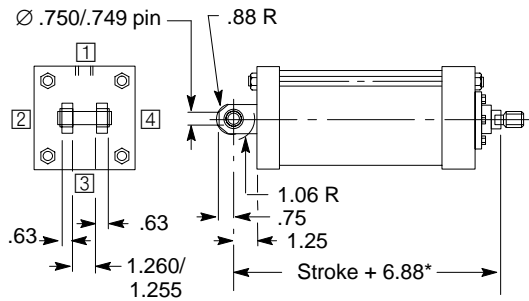

CODE 11 SPHERICAL BEARING MOUNT

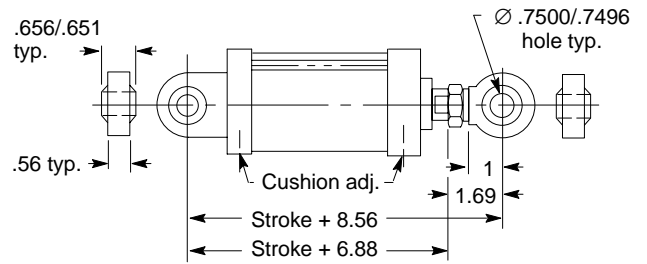

CODE 12 CAP RECTANGULAR FLANGE MOUNT†

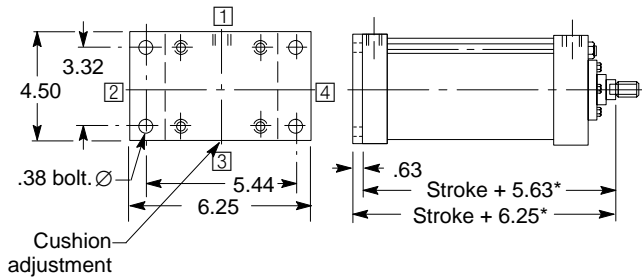

CODE 13 CAP SQUARE FLANGE MOUNT

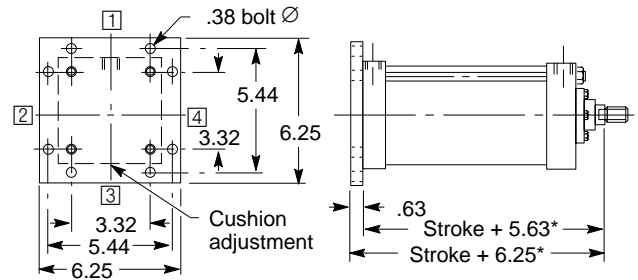

CODE 15 INTERMEDIATE TRUNNION MOUNT

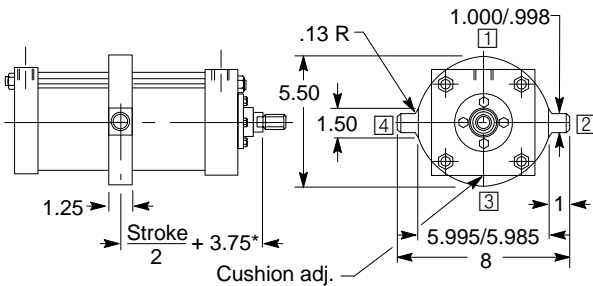

CODE 16 CAP TRUNNION MOUNT

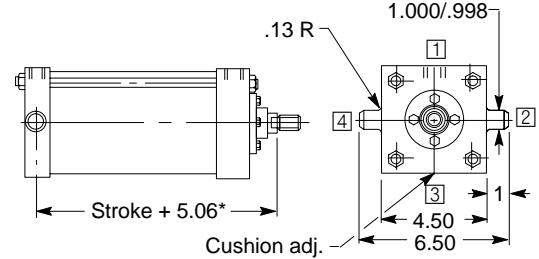

CODE 17 HEAD TRUNNION MOUNT

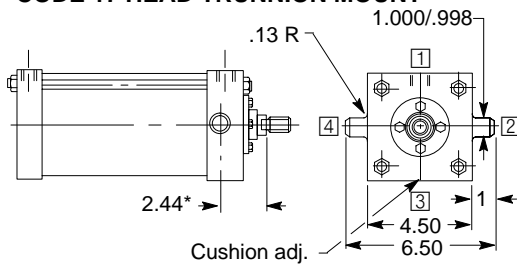

CODE 21 CAP EXTENDED TIE ROD MOUNT

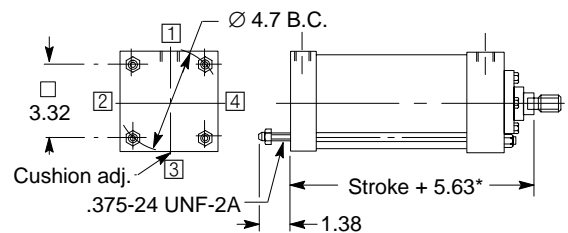

CODE 22 HEAD EXTENDED TIE ROD MOUNT

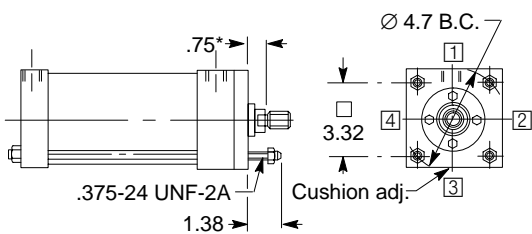

CODE 23 BOTH ENDS EXTENDED TIE ROD MOUNT

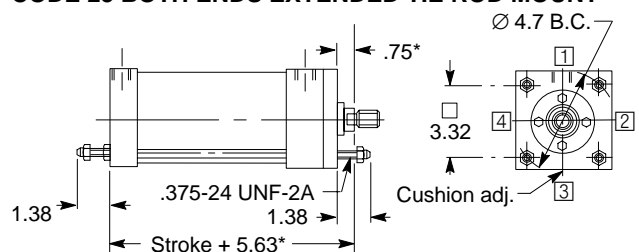

†Maximum working pressure 800 PSI (for minimum flange deflection)

5 inch Cylinder Bore

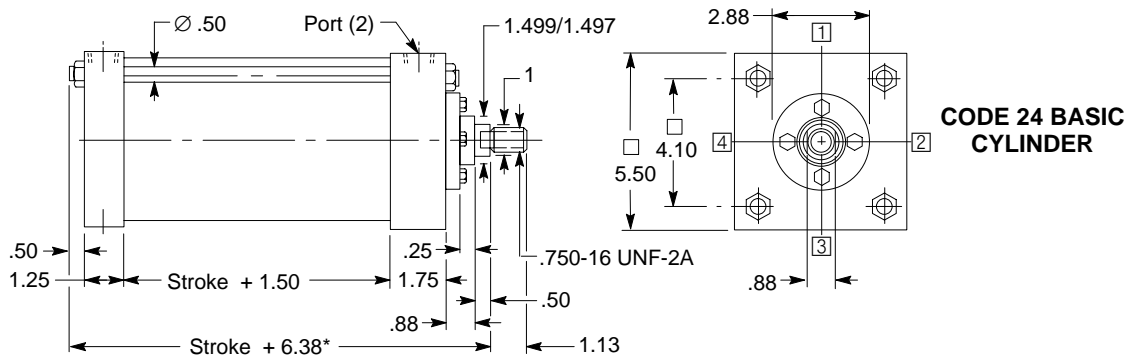

ALTERNATE ROD SIZES AVAILABLE (in inches)	ROD DIA. MM	DIMENSIONAL CHANGES THAT OCCUR AS ROD DIAMETER IS CHANGED								
		Add "N" to all dimensions marked with *.								
		N*	A	B +.000 -.002	C	D	RD	VB	V	
1 3/8	.25	1.63	1.999	.63	1.13	3.38	1	.38	1.000-14 UNS-2A	
1 3/4	.50	2	2.374	.75	1.50	3.38	1.13	.50	1.250-12 UNF-2A	
2	.63	2.25	2.624	.88	1.69	4	1.13	.50	1.500-12 UNF-2A	
2 1/2	.88	3	3.124	1	2.06	4.50	1.25	.63	1.875-12 UN-2A	
3	.88	3.50	3.749	1	2.63	5	1.25	.63	2.250-12 UN-2A	
3 1/2	.88	3.50	4.249	1	3	5.25	1.25	.63	2.500-12 UN-2A	

CODE 25 DOUBLE ROD SIDE LUG MOUNT

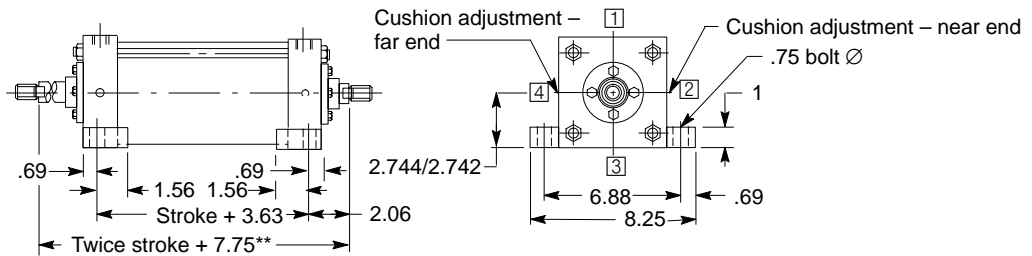

CODE 01 SIDE LUG MOUNT

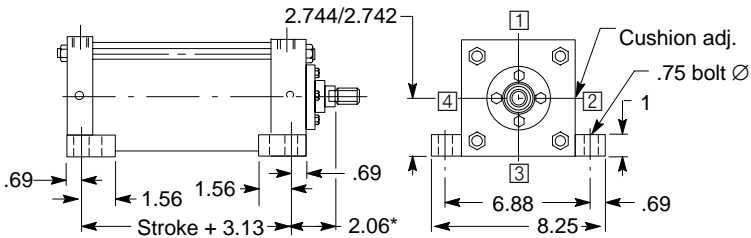

CODE 02 TAPPED MOUNT

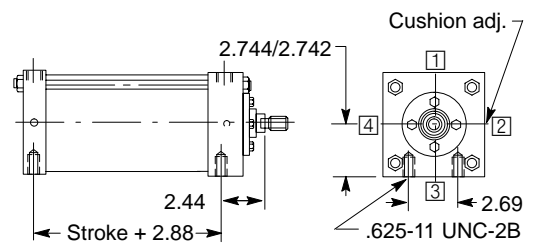

CODE 07 HEAD RECTANGULAR FLANGE MOUNT †

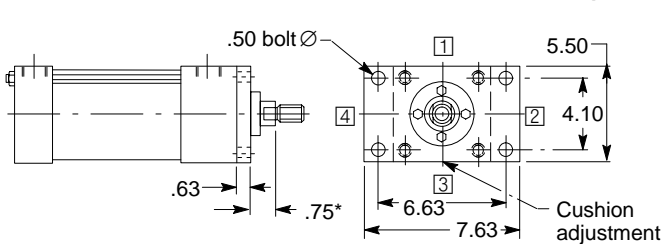

CODE 08 HEAD SQUARE FLANGE MOUNT

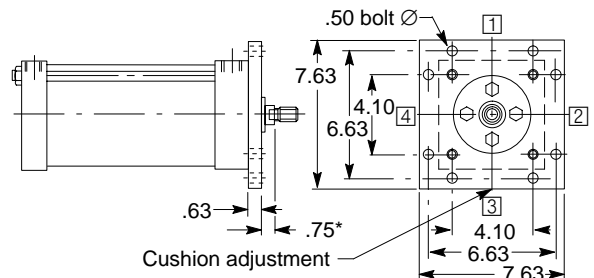

†Maximum working pressure 800 PSI (for minimum flange deflection)

CODE 10 CLEVIS MOUNT

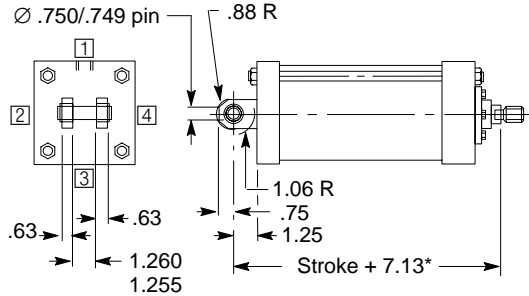

CODE 11 SPHERICAL BEARING MOUNT

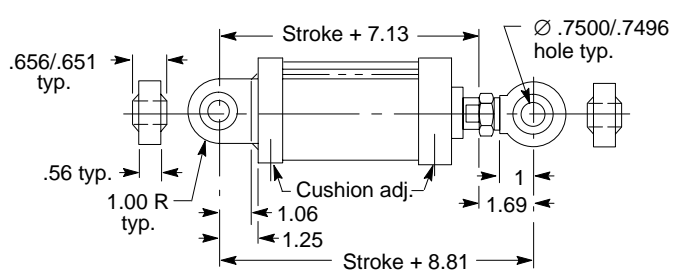

CODE 12 CAP RECTANGULAR FLANGE MOUNT†

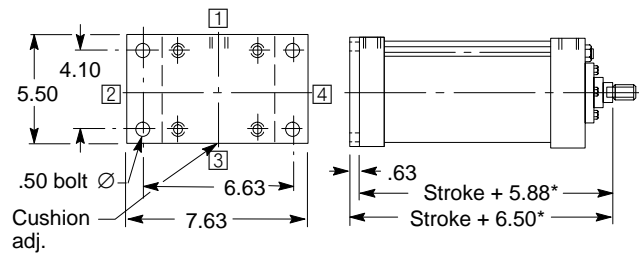

CODE 13 CAP SQUARE FLANGE MOUNT

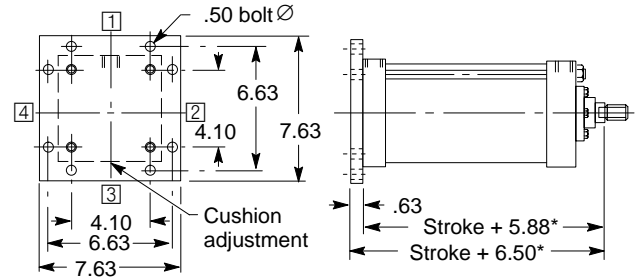

CODE 15 INTERMEDIATE TRUNNION MOUNT

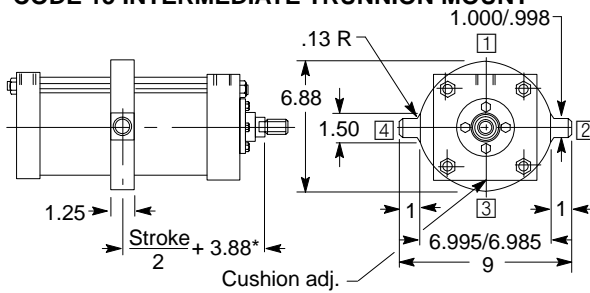

CODE 16 CAP TRUNNION MOUNT

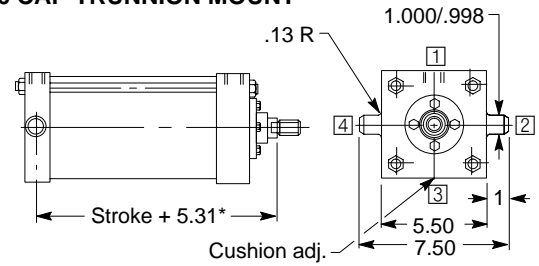

CODE 17 HEAD TRUNNION MOUNT

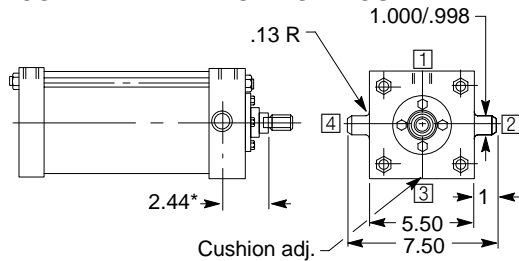

CODE 21 CAP EXTENDED TIE ROD MOUNT

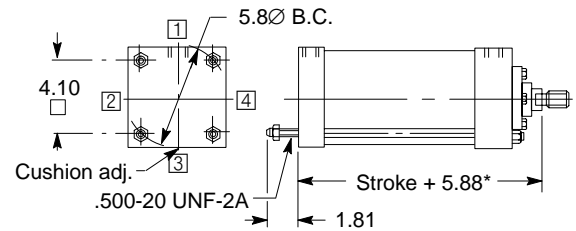

CODE 22 HEAD EXTENDED TIE ROD MOUNT

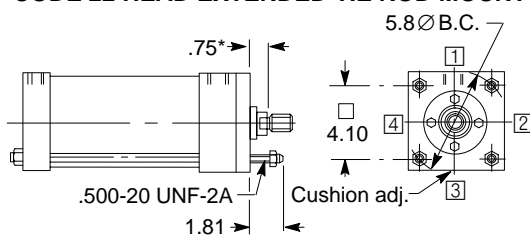

CODE 23 BOTH ENDS EXTENDED TIE ROD MOUNT

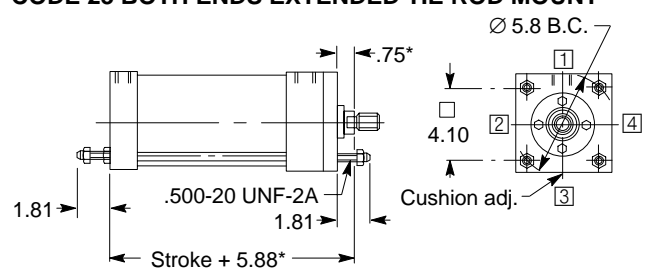

†Maximum working pressure 800 PSI (for minimum flange deflection)

6 inch Cylinder Bore

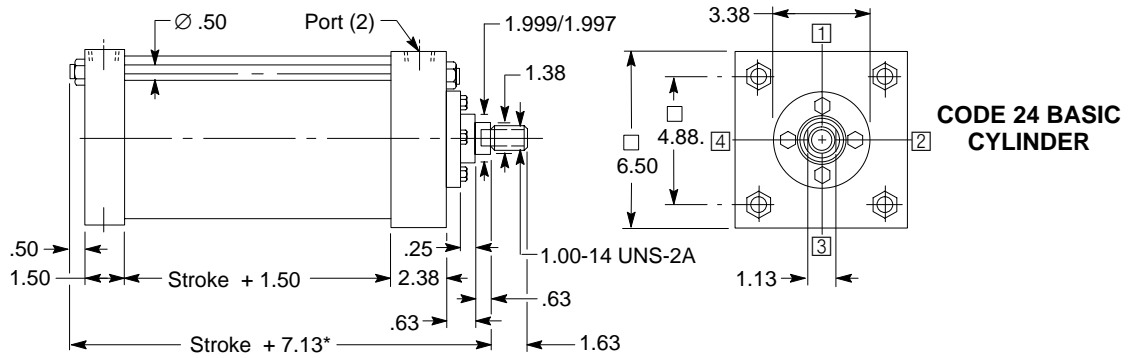

ALTERNATE ROD SIZES AVAILABLE (in inches)	ROD DIA. MM	DIMENSIONAL CHANGES THAT OCCUR AS ROD DIAMETER IS CHANGED									
		N*	A	B	C	D	RD	VB	V	KK thd.	
1 3/4	.25	2	2.374/ 2.372	.75	1.50	3.75	.75	.38	1.250-12 UNF-2A		
2 1/2	.63	3	3.124/ 3.122	1	2.06	4.50	.88	.50	1.875-12 UN-2A		
4	.63	4	4.749/ 4.746	1	3.38	6	.88	.50	3.000-12 UN-2A		

CODE 25 DOUBLE ROD SIDE LUG MOUNT

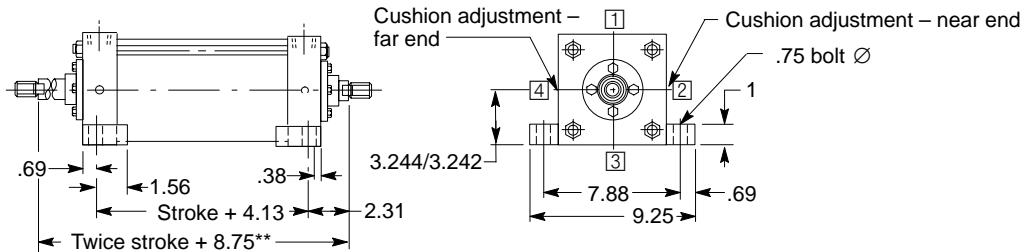

CODE 01 SIDE LUG MOUNT

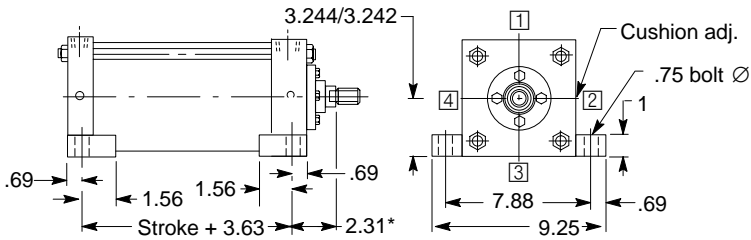

CODE 02 TAPPED MOUNT

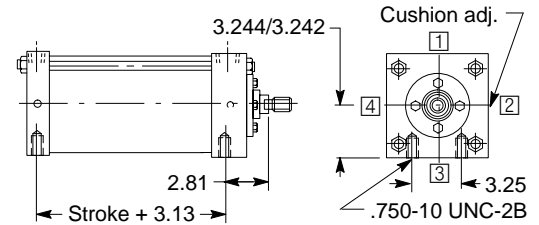

CODE 07 HEAD RECTANGULAR FLANGE MOUNT †

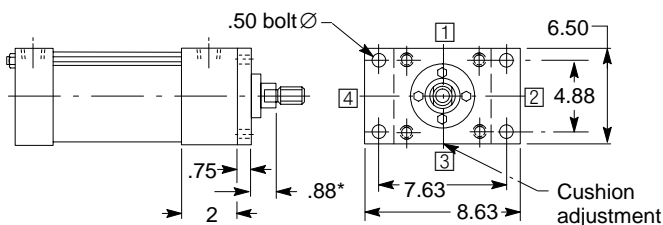

CODE 08 HEAD SQUARE FLANGE MOUNT

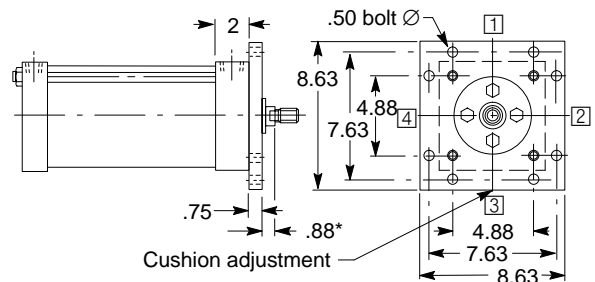

†Maximum working pressure 800 PSI (for minimum flange deflection)

CODE 10 CLEVIS MOUNT

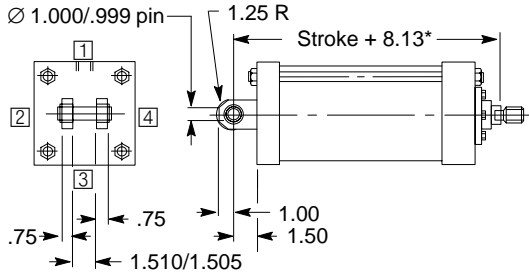

CODE 11 SPHERICAL BEARING MOUNT

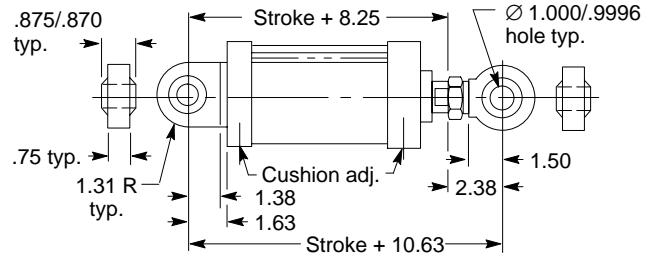

CODE 12 CAP RECTANGULAR FLANGE MOUNT†

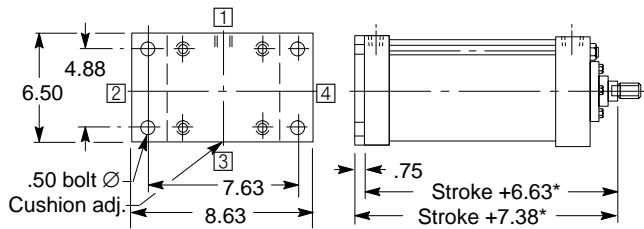

CODE 13 CAP SQUARE FLANGE MOUNT

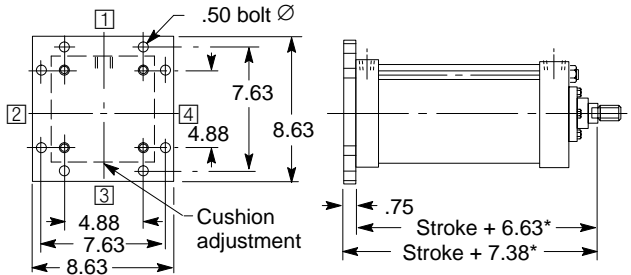

CODE 15 INTERMEDIATE TRUNNION MOUNT

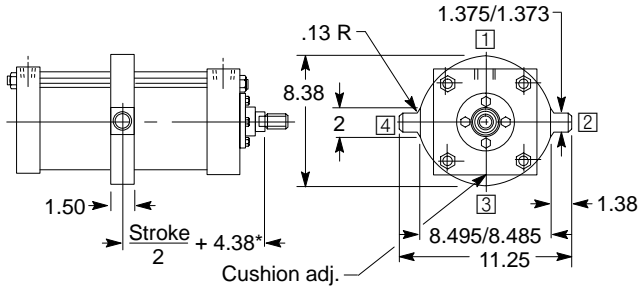

CODE 16 CAP TRUNNION MOUNT

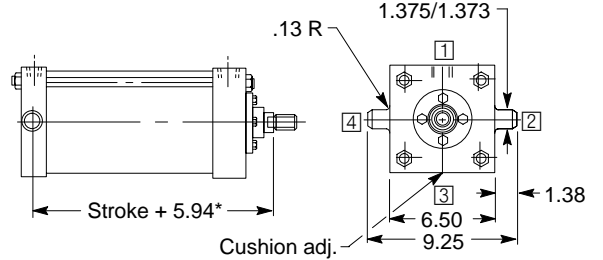

CODE 17 HEAD TRUNNION MOUNT

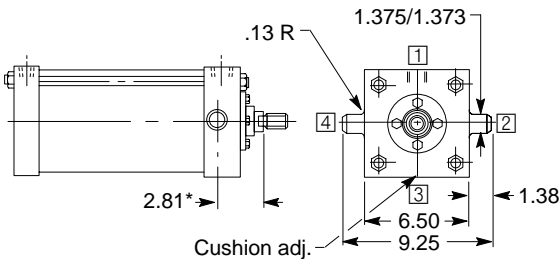

CODE 21 CAP EXTENDED TIE ROD MOUNT

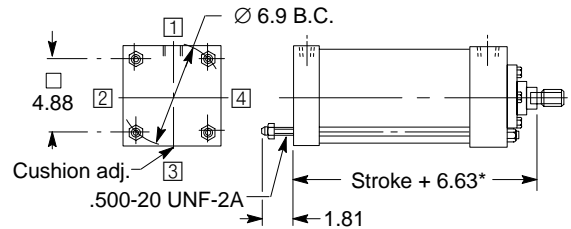

CODE 22 HEAD EXTENDED TIE ROD MOUNT

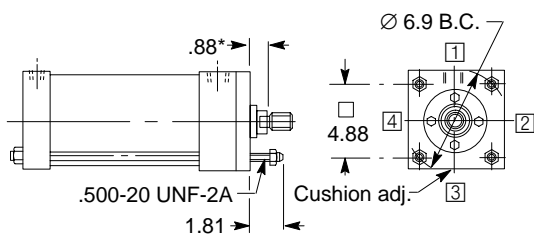

CODE 23 BOTH ENDS EXTENDED TIE ROD MOUNT

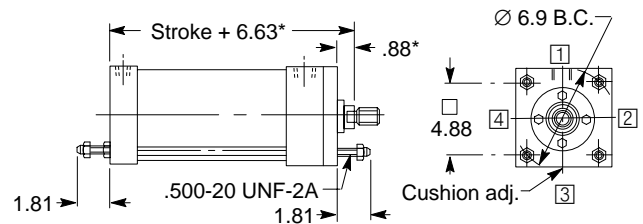

†Maximum working pressure 800 PSI (for minimum flange deflection)

7 inch Cylinder Bore

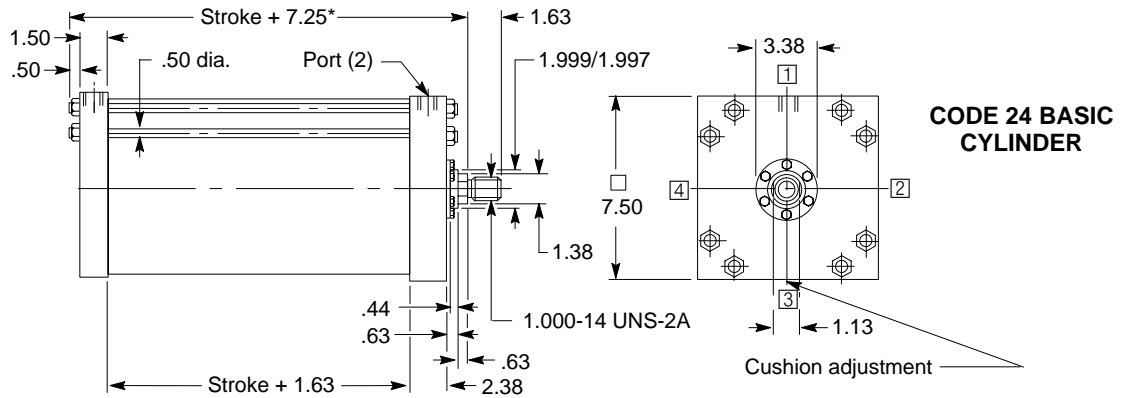

ALTERNATE ROD SIZES AVAILABLE (in inches)	ROD DIA. MM	DIMENSIONAL CHANGES THAT OCCUR AS ROD DIAMETER IS CHANGED										
		N*	A	B	C	D	RD	VB	V	KK thd.	RM	
1 3/4	.25	2	2.374/ 2.372	.75	1.50	3.75	.75	.63	1.250-12 UNF-2A	4.499		
3	.63	3.50	3.749/ 3.747	1	2.63	5.50	.88	.63	2.250-12 UN-2A	6.249		
5	.63	5	5.749/ 5.746	1	4.25	6.88	.88	.50	3.500-12 UN-2A	6.874		

Add "N" to all dimensions marked with *.

CODE 25 DOUBLE ROD SIDE LUG MOUNT

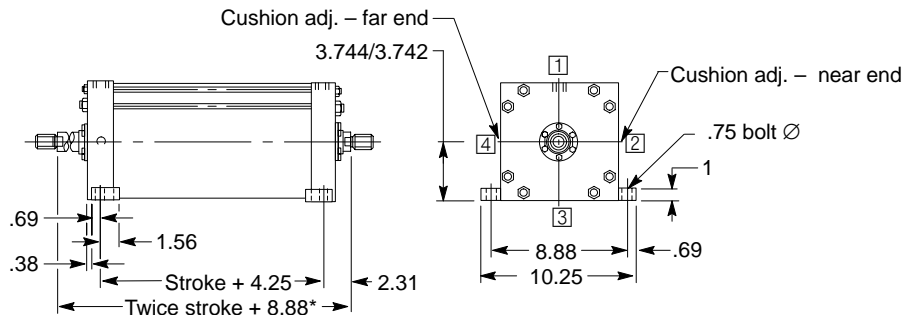

CODE 01 SIDE LUG MOUNT

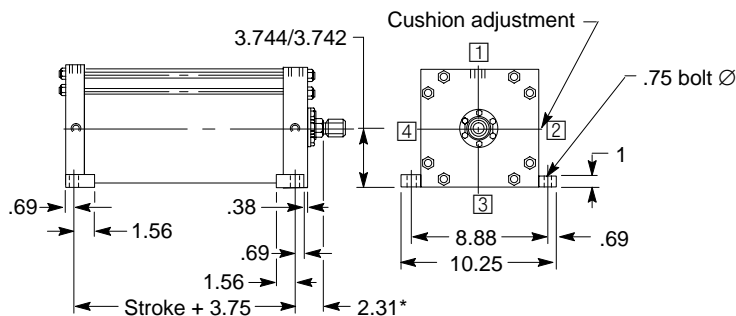

CODE 07 HEAD FLANGE MOUNT

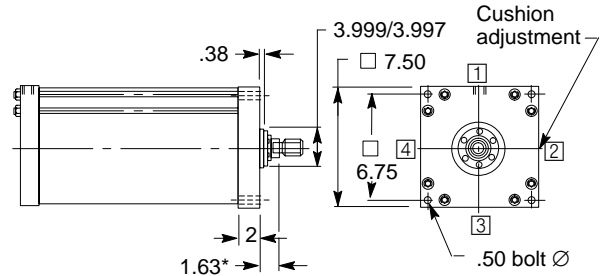

CODE 10 CLEVIS MOUNT

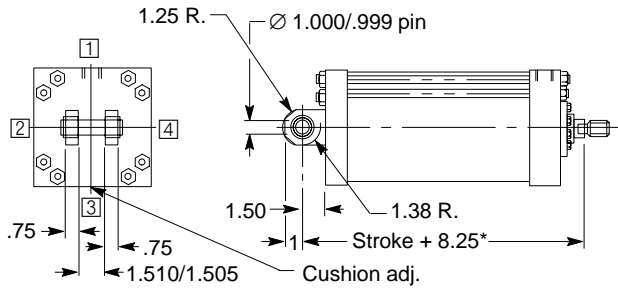

CODE 11 SPHERICAL BEARING MOUNT

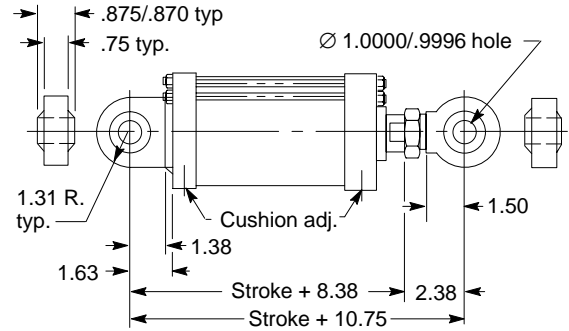

CODE 12 CAP RECTANGULAR FLANGE MOUNT†

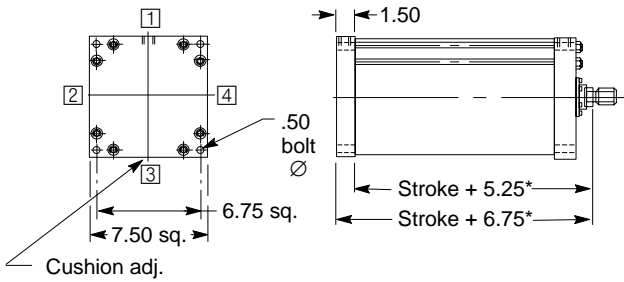

CODE 15 INTERMEDIATE TRUNNION MOUNT

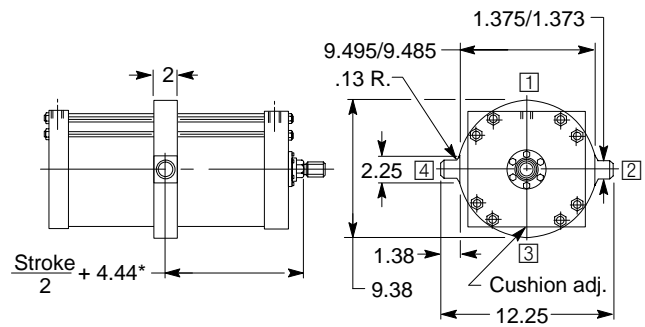

CODE 16 CAP TRUNNION MOUNT

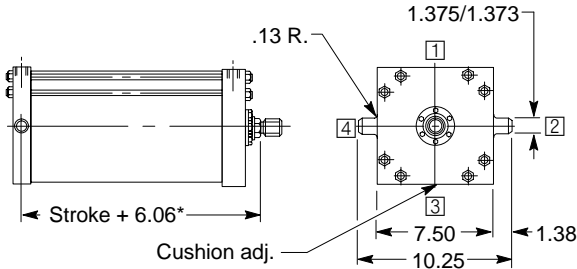

CODE 17 HEAD TRUNNION MOUNT

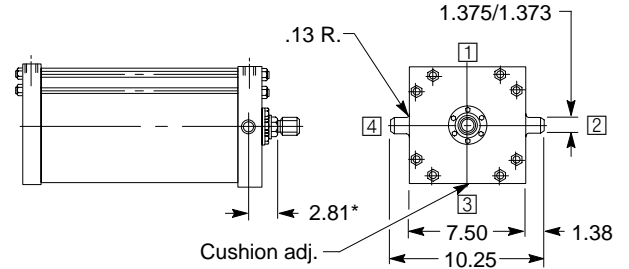

8 inch Cylinder Bore

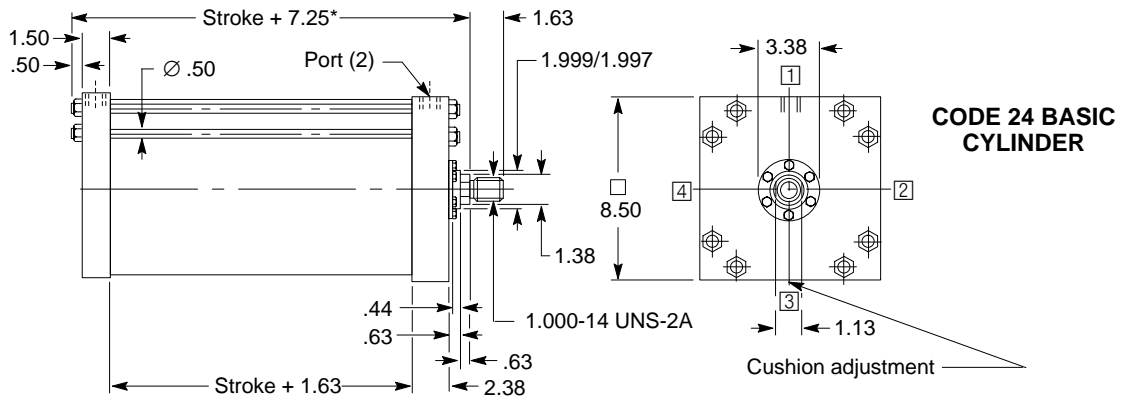

ALTERNATE ROD SIZES AVAILABLE (in inches)	ROD DIA. MM	DIMENSIONAL CHANGES THAT OCCUR AS ROD DIAMETER IS CHANGED										
		N*	A	B	C	D	RD	VB	V	KK thd.	RM†	
1 3/4	.25	2	2.374/ 2.372	.75	1.50	3.75	.75	.56	1.250-12 UNF-2A	4.499		
3 1/2	.63	3.50	4.249/ 4.246	1	3	5.88	.88	.63	2.500-12 UN-2A	6.374		
5 1/2	.63	5.50	6.249/ 6.246	1	4.63	7.38	.88	.50	4.000-12 UN-2A	7.374		

† Applies to Code 07 mount only

CODE 25 DOUBLE ROD SIDE LUG MOUNT

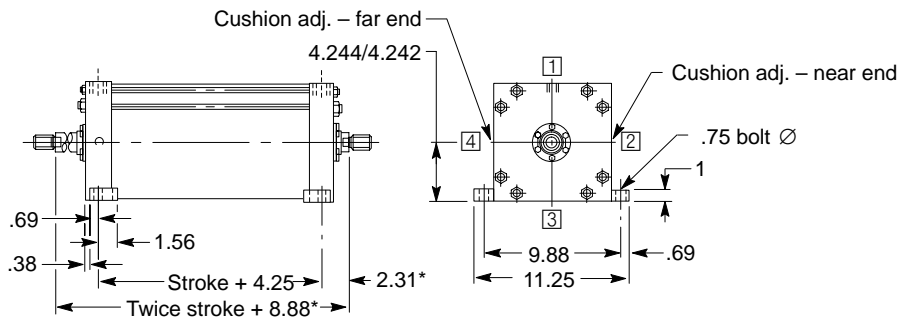

CODE 01 SIDE LUG MOUNT

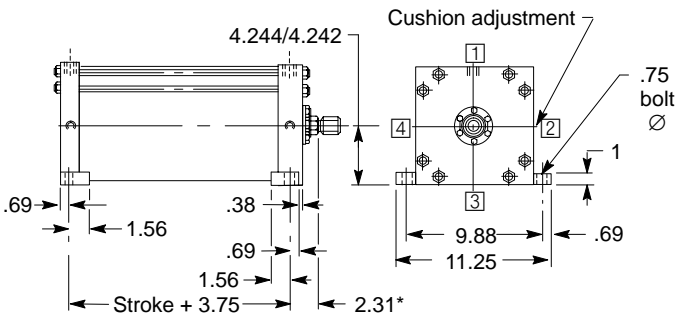

CODE 07 HEAD FLANGE MOUNT

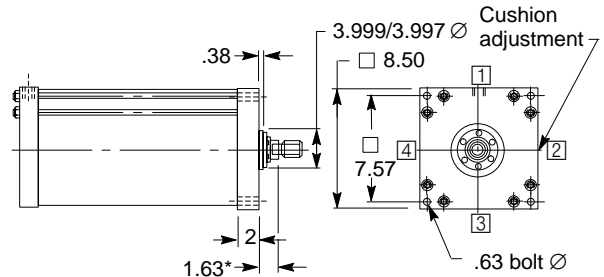

CODE 10 CLEVIS MOUNT

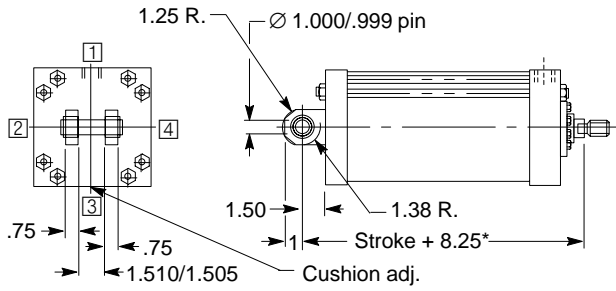

CODE 11 SPHERICAL BEARING MOUNT

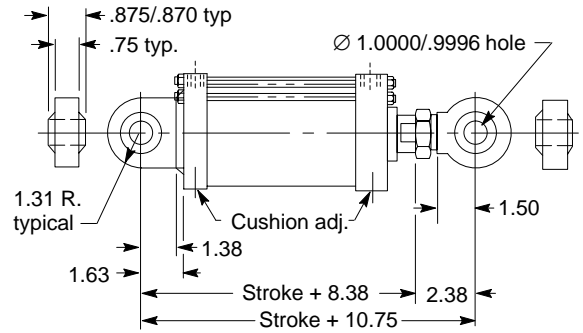

CODE 12 CAP RECTANGULAR FLANGE MOUNT†

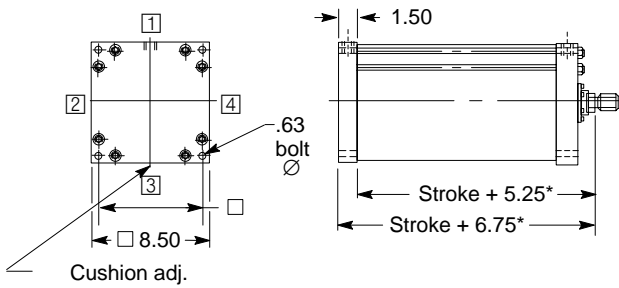

CODE 15 INTERMEDIATE TRUNNION MOUNT

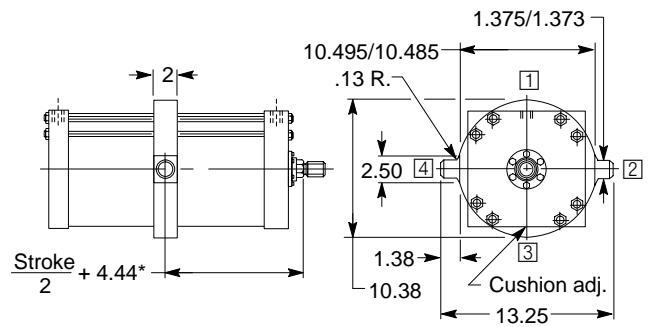

CODE 16 CAP TRUNNION MOUNT

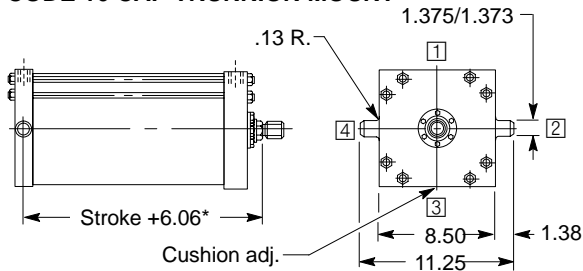

CODE 17 HEAD TRUNNION MOUNT

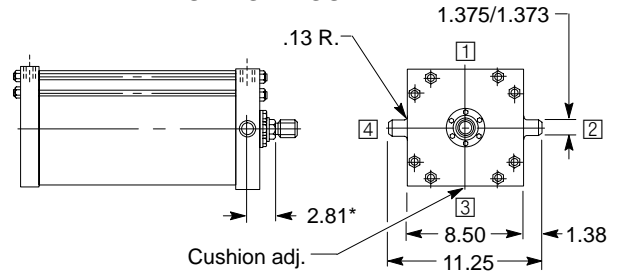

10 inch Cylinder Bore

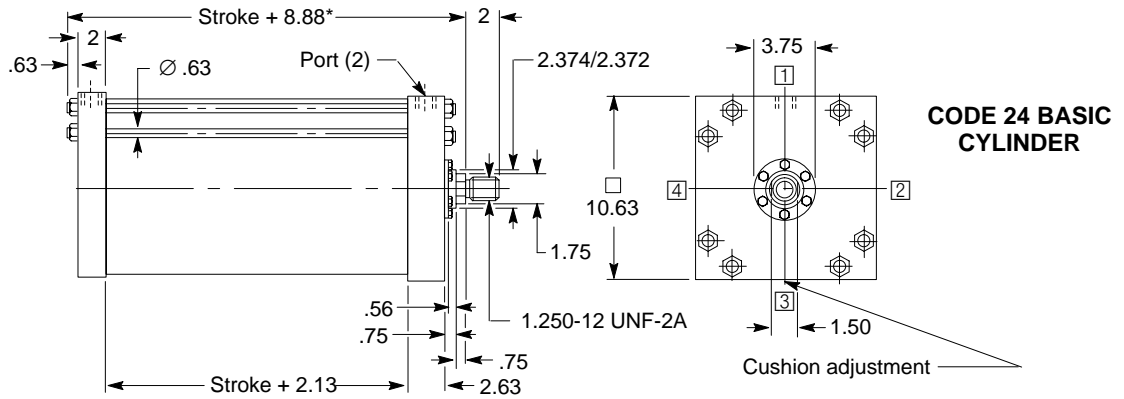

ALTERNATE ROD SIZES AVAILABLE (in inches)	ROD DIA. MM	DIMENSIONAL CHANGES THAT OCCUR AS ROD DIAMETER IS CHANGED										
		N*	A	B	C	D	RD	VB	V	KK thd.	RM†	
2	.13	2.25	2.624/ 2.622	.88	1.69	4	.75	.63	1.500-12 UNF-2A	4.749		
3 1/2	.38	3.50	4.249/ 4.246	1	3	5.88	.88	.63	2.500-12 UN-2A	6.374		
5 1/2	.38	5.50	6.249/ 6.245	1	4.63	7.38	.88	.50	4.000-12 UN-2A	7.374		

† Applies to Code 07 mount only

CODE 25 DOUBLE ROD SIDE LUG MOUNT

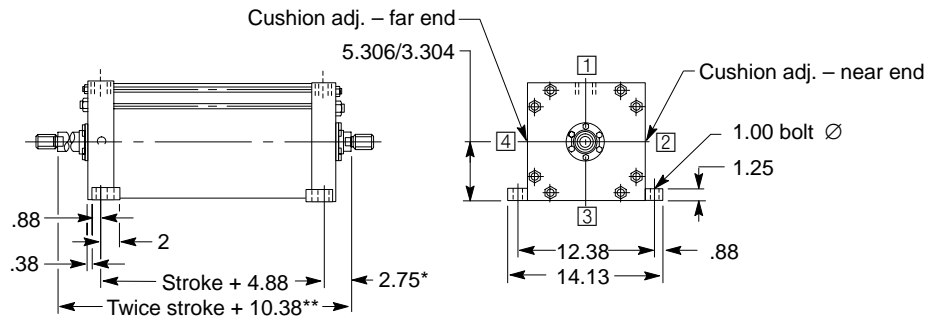

CODE 01 SIDE LUG MOUNT

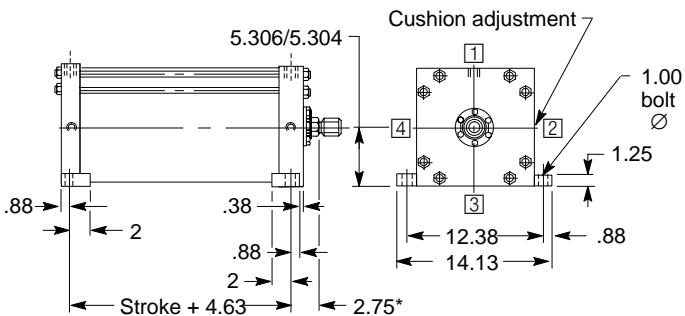

CODE 07 HEAD FLANGE MOUNT

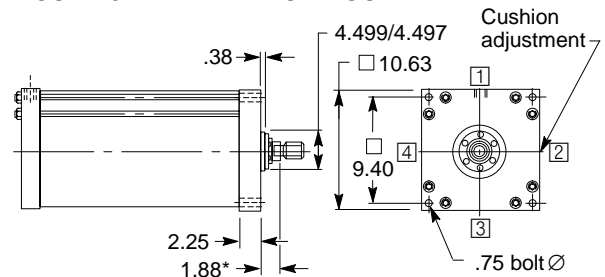

CODE 10 CLEVIS MOUNT

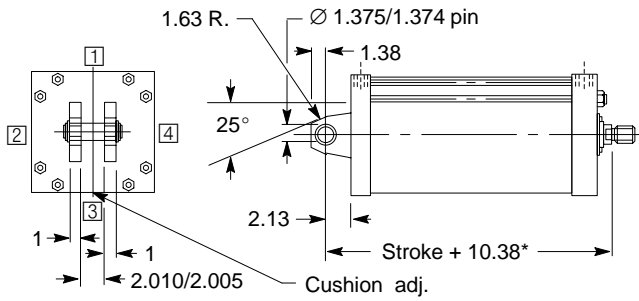

CODE 11 SPHERICAL BEARING MOUNT

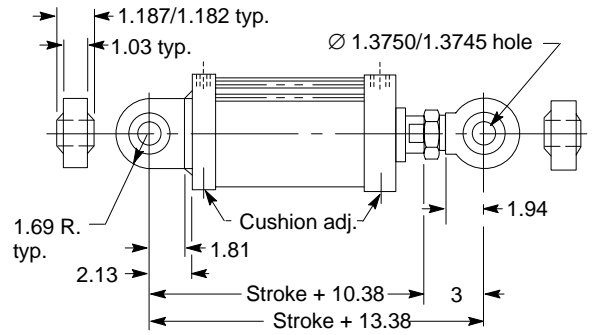

CODE 12 CAP RECTANGULAR FLANGE MOUNT†

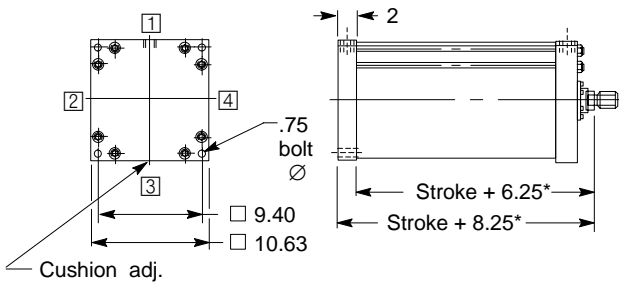

CODE 15 INTERMEDIATE TRUNNION MOUNT

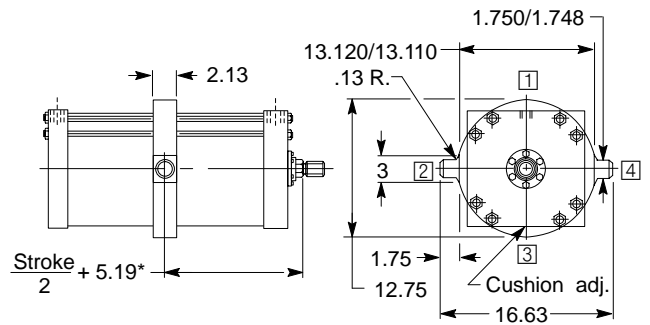

CODE 16 CAP TRUNNION MOUNT

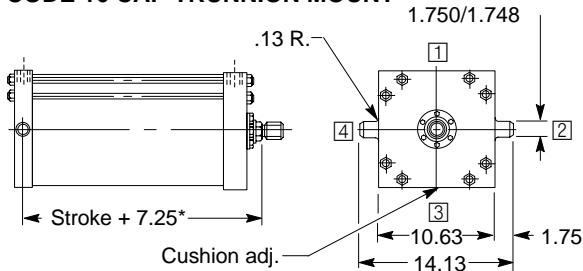

CODE 17 HEAD TRUNNION MOUNT

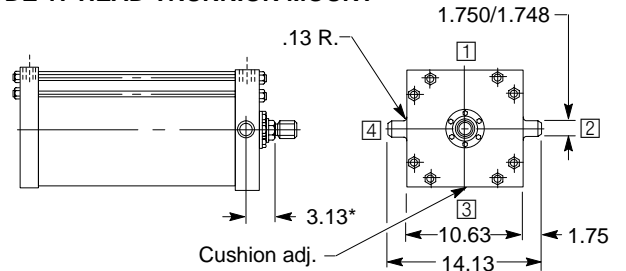

12 inch Cylinder Bore

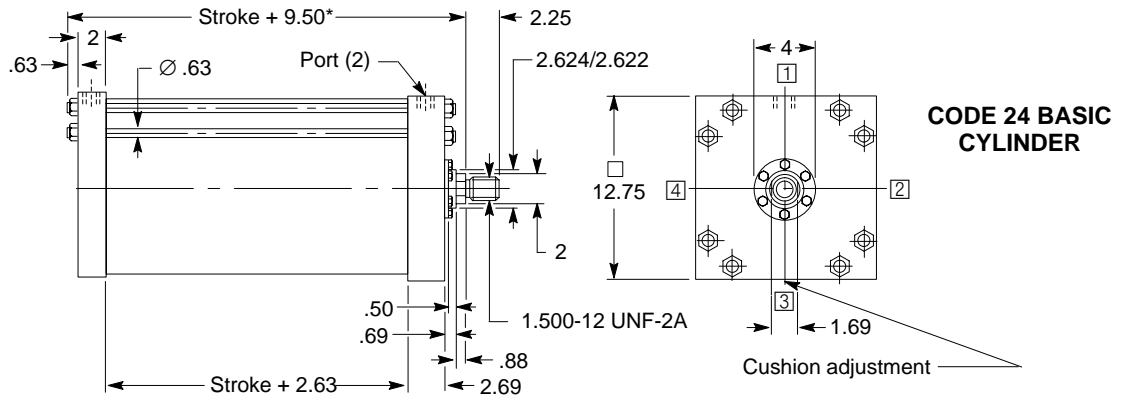

ALTERNATE ROD SIZES AVAILABLE (in inches)	ROD DIA. MM	DIMENSIONAL CHANGES THAT OCCUR AS ROD DIAMETER IS CHANGED									
		N*	A	B	C	D	RD	VB	V	KK thd.	RM†
2 1/2	.25	3	3.124/ 3.122	1	2.06	4.50	.81	.63	1.875-12 UN-2A	5.249	
4	.25	4	4.749/ 4.746	1	3.38	6.38	.81	.56	3.000-12 UN-2A	6.999	
5 1/2	.25	5.50	6.249/ 6.245	1	4.63	7.38	.81	.50	4.000-12 UN-2A	7.374	

Add "N" to all dimensions marked with *.

† Applies to Code 07 mount only

CODE 25 DOUBLE ROD SIDE LUG MOUNT

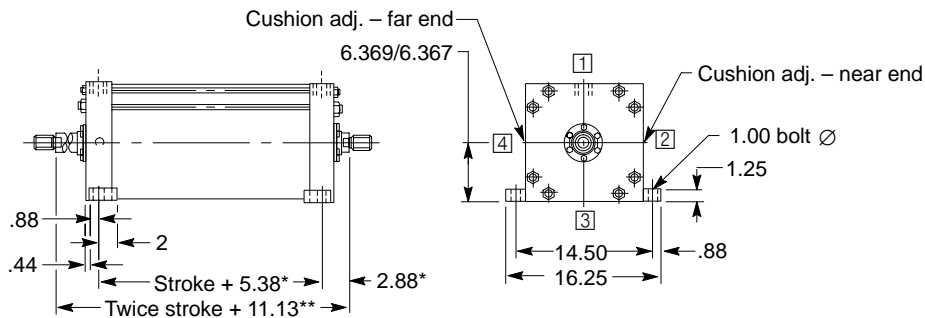

CODE 01 SIDE LUG MOUNT

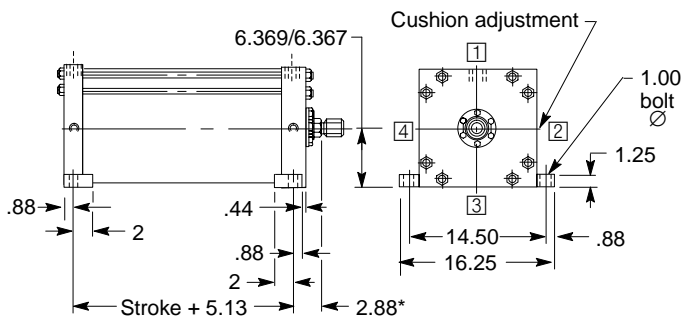

CODE 07 HEAD FLANGE MOUNT

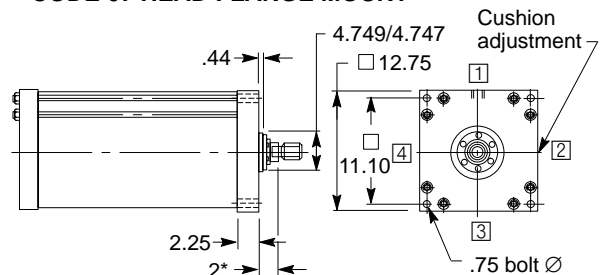

CODE 10 CLEVIS MOUNT

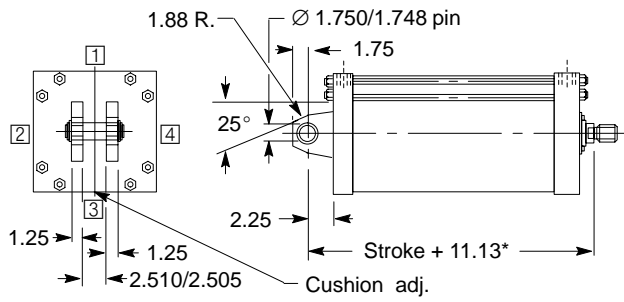

CODE 11 SPHERICAL BEARING MOUNT

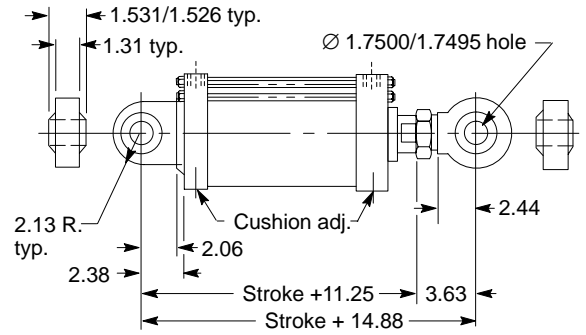

CODE 12 CAP RECTANGULAR FLANGE MOUNT†

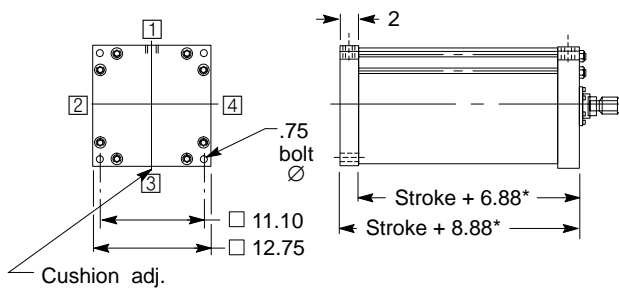

CODE 15 INTERMEDIATE TRUNNION MOUNT

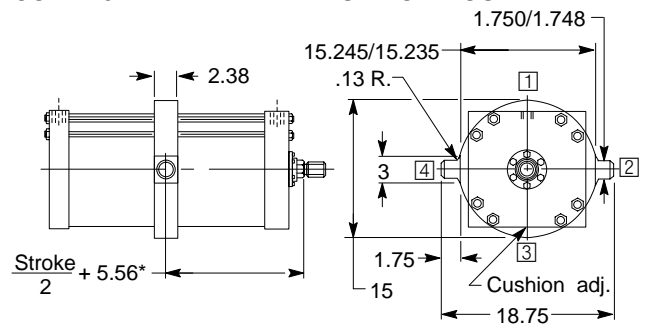

CODE 16 CAP TRUNNION MOUNT

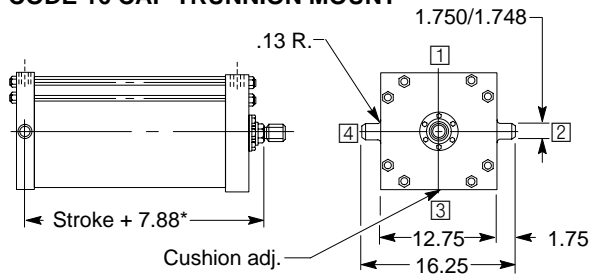

CODE 17 HEAD TRUNNION MOUNT

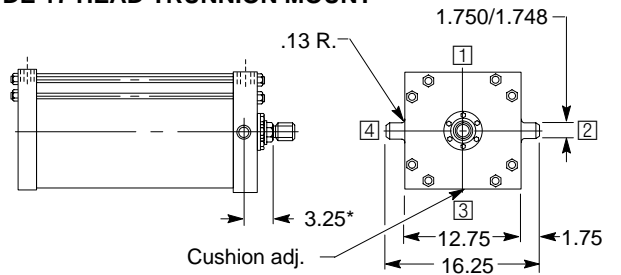

14 inch Cylinder Bore

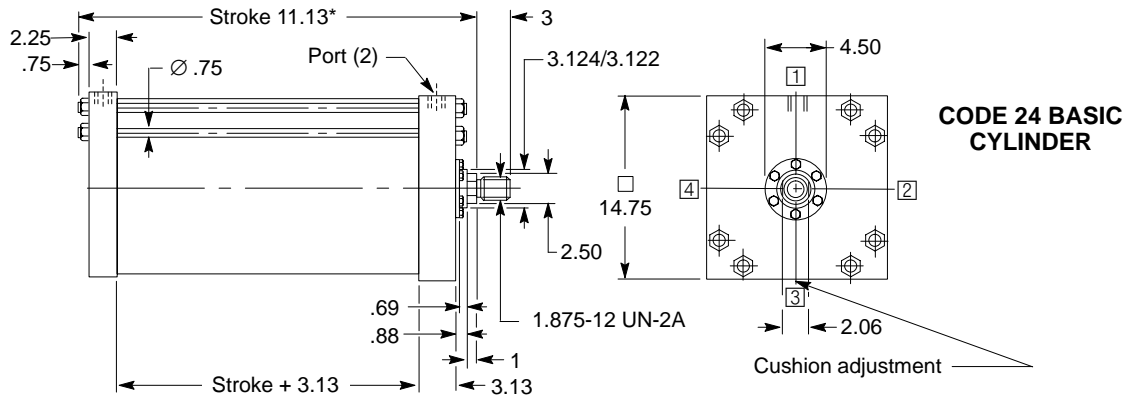

ALTERNATE ROD SIZES AVAILABLE (in inches)	ROD DIA. MM	DIMENSIONAL CHANGES THAT OCCUR AS ROD DIAMETER IS CHANGED										
		N*	A	B	C	D	RD	VB	V	KK thd.	RM†	
	3	-	3.50	3.749/ 3.747	1	2.63	5.50	.88	.63	2.250-12 UN-2A	6.248	
	4	-	4	4.749/ 4.746	1	3.38	6.38	.88	.56	3.000-12 UN-2A	6.999	
	5 1/2	-	5.50	6.249/ 6.245	1	4.63	7.38	.88	.50	4.000-12 UN-2A	7.374	

† Applies to Code 07 mount only

CODE 25 DOUBLE ROD SIDE LUG MOUNT

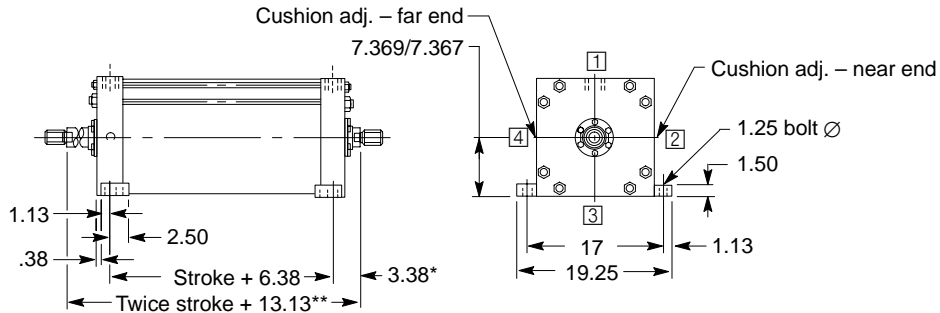

CODE 01 SIDE LUG MOUNT

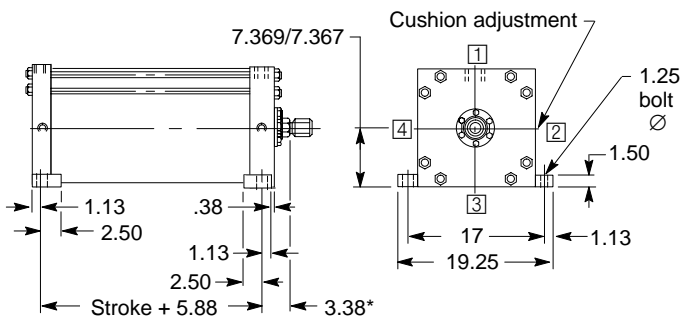

CODE 07 HEAD FLANGE MOUNT

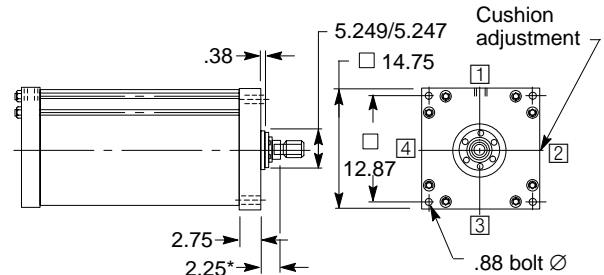

CODE 10 CLEVIS MOUNT

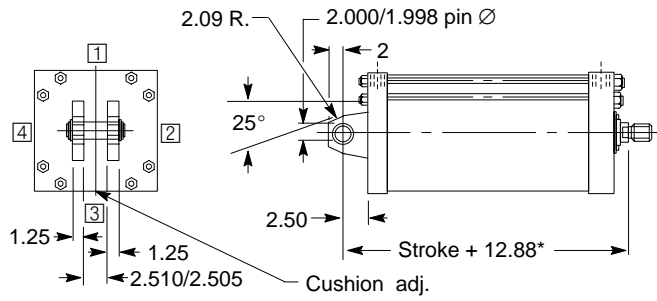

CODE 11 SPHERICAL BEARING MOUNT

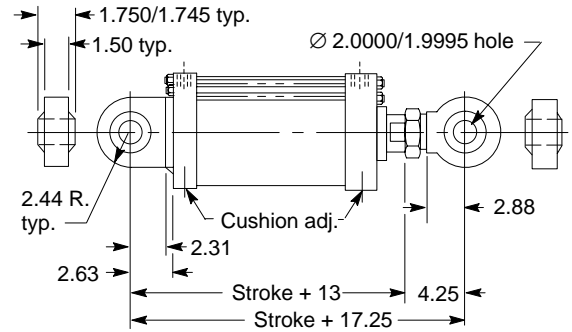

CODE 12 CAP RECTANGULAR FLANGE MOUNT†

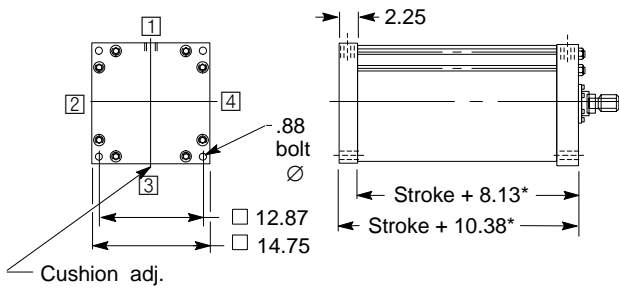

CODE 15 INTERMEDIATE TRUNNION MOUNT

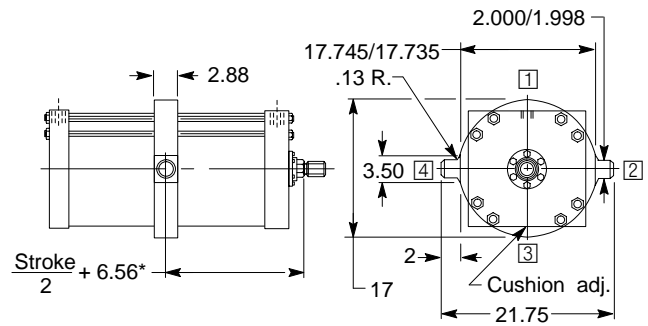

CODE 16 CAP TRUNNION MOUNT

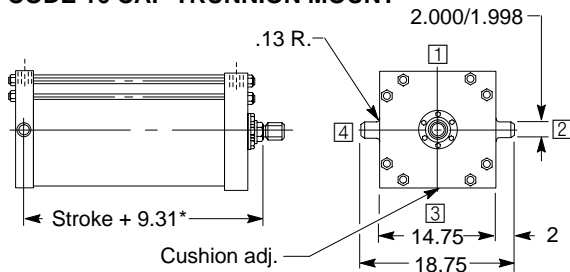

CODE 17 HEAD TRUNNION MOUNT

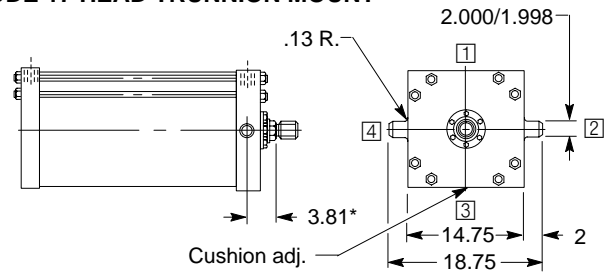

Accessories

Rod eyes, rod clevises and mounting brackets are available from Vickers. These accessories are detailed on the following pages, showing part numbers and all pertinent dimensional data. When ordering, please specify the part name and part number.

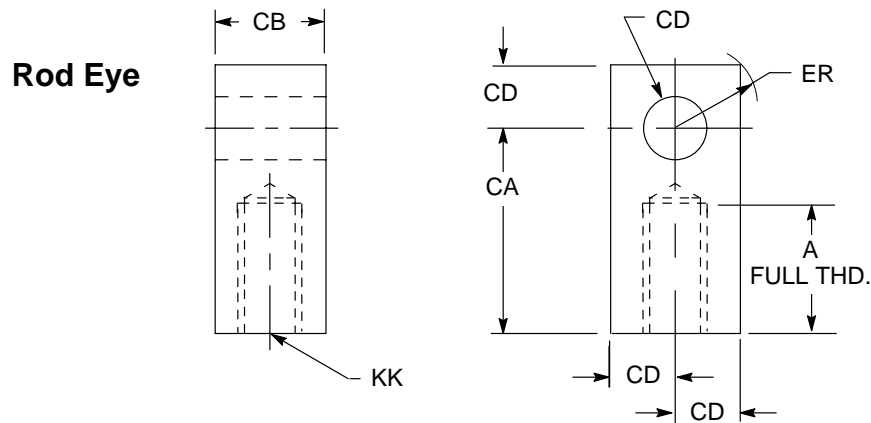

Bore dia.	A	CA	CB	CD	ER	KK thread		Part no.	Weight (lbs.)
						Size	Torque (ft. lbs.)*		
1 1/2, 2, 2 1/2	.75	1.50	.75	.50	.70	.4375-20 UNF-2B	36	S-1-560	.38
3 1/4, 4, 5	1.13	2.06	1.25	.75	1.06	.750-16 UNF-2B	125	S-460	1.25
6, 7, 8	1.63	2.81	1.50	1.00	1.42	1.000-14 NS-2B	250	S-660	2.50
10	2.00	3.44	2.00	1.38	1.94	1.250-12 UNF-2B	460	S-1060	5.94
12	2.25	4.00	2.50	1.75	2.94	1.500-12 UNF-2B	663	SH-560	11.4
14	3.00	5.00	2.50	2.00	2.81	1.875-12 UN-2B	944	SH-660	15.1

*Recommended values using MoS₂ lubricant or equivalent.
All rod accessories must be torqued against the rod shoulder.

Rod Clevis

(includes swivel pin and retaining rings)

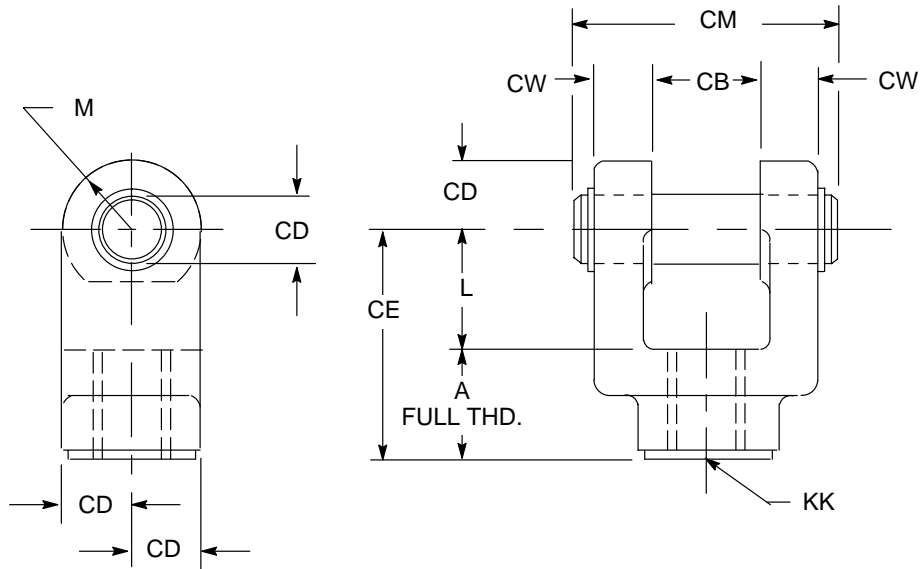

Bore dia.	A	CB	CD	CE	CM	CW
1 1/2, 2, 2 1/2	.75	.75	.50	1.50	2.00	.50
3 1/4, 4, 5	1.13	1.25	.75	2.38	2.75	.63
6, 7, 8	1.63	1.50	1.00	3.13	3.28	.75
10	2.00	2.00	1.38	4.13	4.28	1.00
12	2.25	2.50	1.75	4.50	5.44	1.25
14	3.00	2.50	2.00	5.50	5.44	1.25

Bore dia.	KK thread		L (ref.)	M	Part no.	Weight (lbs.)
	Size	Torque (ft. lbs.)*				
1 1/2, 2, 2 1/2	.4375-20 UNF-2B	36	.75	.50	S-1-562-10	.56
3 1/4, 4, 5	.750-16 UNF-2B	125	1.25	.75	S-462-10	1.56
6, 7, 8	1.000-14 NS-2B	250	1.50	1.00	S-662-10	3.31
10	1.250-12 UNF-2B	460	2.13	1.38	S-1062-10	9.25
12	1.500-12 UNF-2B	663	2.25	1.75	SH-562-10	14.62
14	1.875-12 UN-2B	944	2.50	2.25	SH-662-10	21.00

*Recommended values using MoS₂ lubricant or equivalent. All rod accessories must be torqued against the rod shoulder.

Swivel pin for rod clevis (includes two retaining rings)

Bore dia.	CD	CL	CM	Part no.
1 1/2, 2, 2 1/2	.500/.499	1.82	2.00	S-1-583-10
3 1/4, 4, 5	.750/.749	2.57	2.75	S-483-10
6, 7, 8	1.000/.999	3.06	3.28	S-683-10
10	1.375/1.374	4.06	4.28	SH-483-10
12	1.750/1.748	5.06	5.44	SH-583-10
14	2.000/1.998	5.06	5.44	SH-683-10

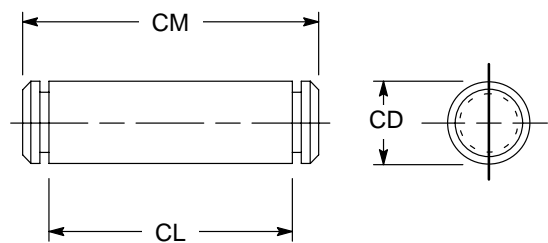

Accessories

Mounting Eye Bracket

(for clevis mount cylinders)

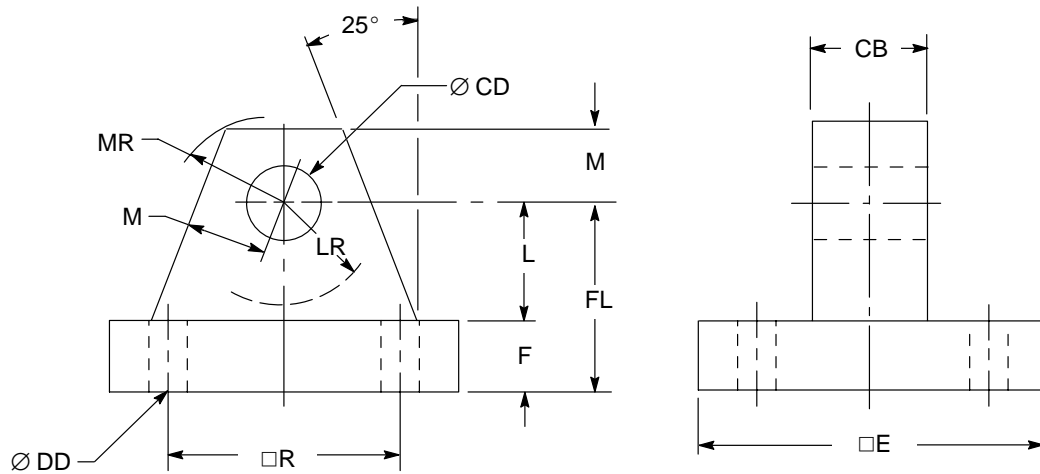

Bore diameter	CB	CD	DD	E	F	FL	L (ref.)	LR	M	MR	Part no.	Weight (lbs.)
1 1/2, 2, 2 1/2	.75	.50	.38	2.50	.38	1.13	.75	.69	.50	.59	S-1-552-M	.94
3 1/4, 4, 5	1.25	.75	.50	3.50	.63	1.88	1.25	1.13	.75	.88	S-452-M	3.19
6, 7, 8	1.50	1.00	.63	4.50	.75	2.25	1.50	1.38	1.00	1.25	S-652-M	6.50
10	2.00	1.38	.63	5.00	.88	3.00	2.13	1.88	1.38	1.63	S-1052-M	11.7
12	2.50	1.75	.88	6.50	.88	3.13	2.25	2.00	1.75	1.88	SH-552-M	19.2
14	2.50	2.00	1.00	7.50	1.00	3.50	2.50	2.25	2.25	2.09	SH-652-M	27

Accessories for Spherical Bushing Mounted Cylinders 4

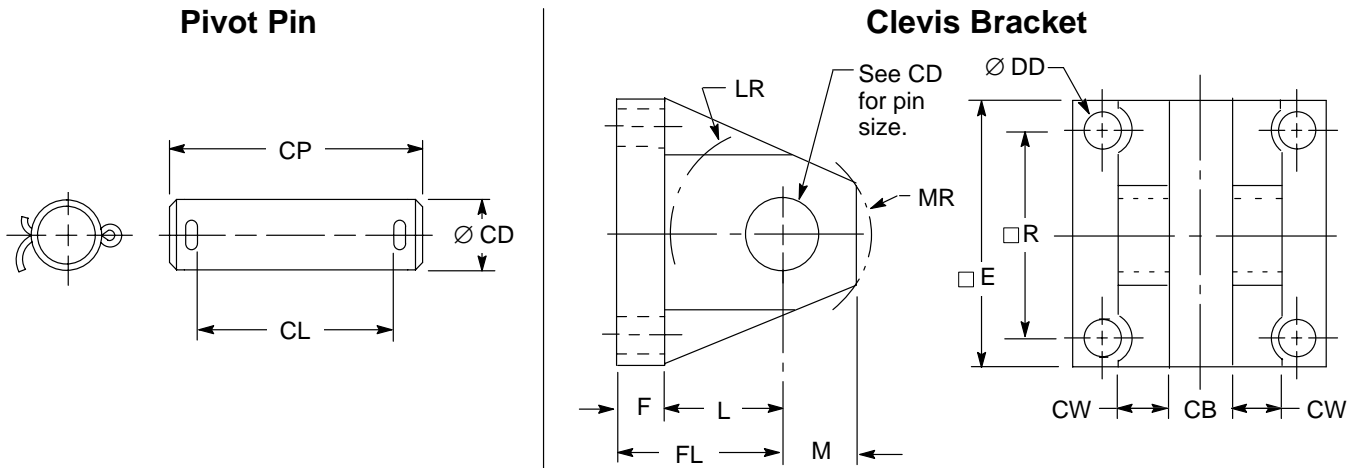

Bore dia.	CB	CD	CL	CP	CW	DD	E	F	FL	L(Ref)	LR	M	MR	R
1 1/2, 2, 2 1/2	.467 .472	.4997 .4992	1.47	2.19	.50	.38	2.50	.38	1.13	.75	.63	.50	.625	1.63
3 1/4, 4, 5	.686 .691	.7497 .7492	1.94	2.69	.63	.50	3.50	.63	1.88	1.25	1.13	.75	.875	2.55
6, 7, 8	.935 .940	.9996 .9991	2.44	3.19	.75	.63	4.50	.75	2.25	1.50	1.38	1.00	1.250	3.25
10	1.247 1.251	1.3745 1.3739	3.25	4.31	1.00	.63	5.00	.88	3.00	2.13	1.88	1.38	1.625	3.82
12	1.591 1.596	1.7495 1.7489	4.09	5.19	1.25	.88	6.50	.88	3.13	2.25	2.13	1.75	1.875	4.95
14	1.810 1.815	1.9995 1.9989	4.31	5.38	1.25	1.00	7.50	1.00	3.50	2.50	2.44	2.00	2.094	5.73

Bore diameter	Accessory part numbers				
	Spherical rod eye w/bushing*	Replacement bushing only*	SAB clevis bracket†	Pivot pin assembly†	Jam nut part number/size‡
1 1/2, 2, 2 1/2	S-1-560-SAB-10	6803-8	S-1-552-M-SAB	6856A-1-10	5202-008 .4375-20
3 1/4, 4, 5	S-460-SAB-10	6803-12	S-452-M-SAB	6856A-2-10	5202-003 .750-16
6, 7, 8	S-660-SAB-10	6803-16	S-652-M-SAB	6856A-3-10	5202-005 1.000-14
10	S-1060-SAB-10	6803-22	S-1052-M-SAB	6856A-4-10	5202-012 1.250-12
12	SH-560-SAB-10	6803-28	SH-552-M-SAB	6856A-5-10	5202-015 1.500-12
14	SH-660-SAB-10	6803-32	SH-652-M-SAB	6856A-6-10	5202-019 1.875-12

* Included in assembly

† Order separately.

‡ Use jam nut to lock rod eye to piston rod.

Rod Sizes and Types

In addition to selecting the correct bore, you must specify the appropriate rod size and rod end configuration for your application.

Four different rod end configurations are available. If a custom design is required, contact your local

Vickers sales engineer, and define your requirements.

The tables on pages 55 through 58 give maximum allowable push strokes at various operating pressures for available rod diameters. Rod ends on

rigid mount cylinders should be supported. Longer strokes are allowable for **pull only** applications. The largest available rod size should be specified for maximum fatigue life. Contact your local Vickers sales engineer for application assistance if necessary.

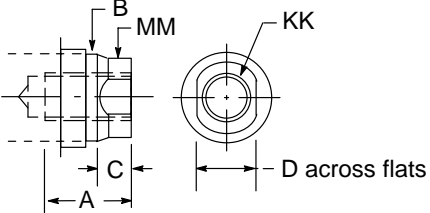
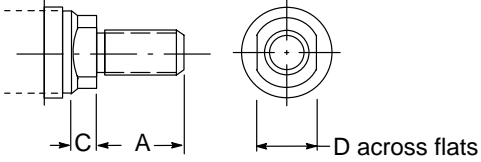
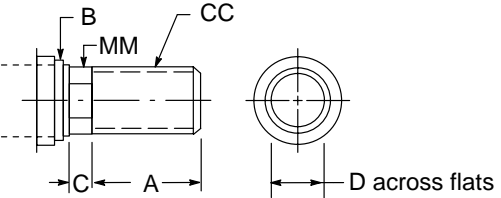
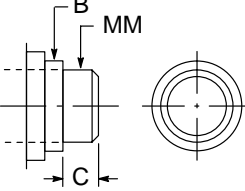
<p>End Type 2</p>		<p>End Type 5</p>	
<p>4</p>		<p>6</p>	

Dimensions in inches

MM rod dia.	C	KK thread	A	B +.000/-.002	D	CC thread
5/8	.37	.4375-20	.75	1.124	.50	.625-18
1	.50	.7500-16	1.12	1.499	.87	1.000-14
1 3/8	.62	1.000-14	1.62	1.999	1.12	1.375-12
1 3/4	.75	1.250-12	2.00	2.374	1.50	1.750-12
2	.87	1.500-12	2.25	2.624	1.69	2.000-12
2 1/2	1.00	1.875-12	3.00	3.124	2.06	2.500-12
3	1.00	2.250-12	3.50	3.749	2.62	3.000-12
3 1/2	1.00	2.500-12	3.50	4.249	3.00	3.500-12
4	1.00	3.000-12	4.00	4.749	3.37	4.000-12
5	1.00	3.500-12	5.00	5.749	4.25	5.000-12
5 1/2	1.00	4.000-12	5.50	6.249	4.62	5.500-12

Port Types, Sizes and Locations

Series TE/TL cylinders have the full flow national pipe thread (NPTF) ports as standard. SAE straight thread O-ring ports are recommended for maximum reliability in Series TF hydraulic applications.

The table below, and on the following page, list the port types and sizes available for each bore diameter.

The tables on pages 53 and 54 list the maximum piston velocities obtainable with each bore diameter and standard port combination, for hydraulic service.

Ports may be located as shown on page 7. Some mounting styles have location restrictions. Where a port or port boss interferes with the cylinder mounting, the mounting takes precedence.

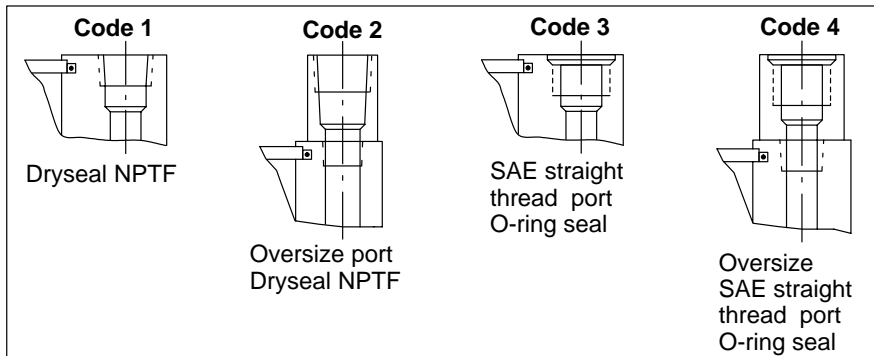

Bore dia. inch	Rod dia. inch	NPTF		Tube dash number	
		Code 1	Code 2	Code 3	Code 4
1 1/2	5/8	3/8	1/2	-6	N/A
	1			N/A	-6
2	5/8	3/8	1/2	-6	N/A
	1				
	1 3/8				
2 1/2	5/8	3/8	1/2	-6	N/A
	1				
	1 3/8				
	1 3/4				
3 1/4	1	1/2	3/4	-10	N/A
	1 3/8			-8	-10
	1 3/4				
	2				
4	1	1/2	3/4	-10	N/A
	1 3/8			-8	-10
	1 3/4				
	2				
	2 1/2				
5	1	1/2	3/4	-10	N/A
	1 3/8				
	1 3/4				
	2				
	2 1/2				
	3			-8	-10
3 1/2					

Bore dia. inch	Rod dia. inch	NPTF		Tube dash number	
		Code 1	Code 2	Code 3	Code 4
6	1 3/8	3/4	1	-12	-14
	1 3/4				
	2 1/2				
	4				
7	1 3/8	3/4	1	-12	-14
	1 3/4				
	3				
	5				
8	1 3/8	3/4	1	-12	-14
	1 3/4				
	3 1/2				
	5 1/2				
10	1 3/4	1	1 1/4	-16	N/A
	2				
	3 1/2				
	5 1/2				
12	2	1	1 1/4	-16	N/A
	2 1/2				
	4				
	5 1/2				
14	2 1/2	1 1/4	1 1/2	-20	N/A
	3				
	4				
	5 1/2				

N/A – Not available

Seal Options

Select the type of piston seal for your application, then select the seal compound from the compatibility chart below.

Determine the correct seal code for your application, then enter it as item 8 in the model code.

Code	Piston seal type	Seal material	
		All seals	Scraper retainer
A	U-cup	Nitrile	Nitrile†
B	Cast iron rings		
C	G.F.T.‡		
D	U-cup	Viton	Viton
E	Cast iron rings		
F	G.F.T.‡		
K	U-cup	Viton	Nitrile
L	Cast iron rings		
M	G.F.T.‡		

† Codes A, B, and C indicate a polyurethane rod wiper in Series TE, TL; a metallic rod scraper in Series TF.
‡ Glass filled Teflon.

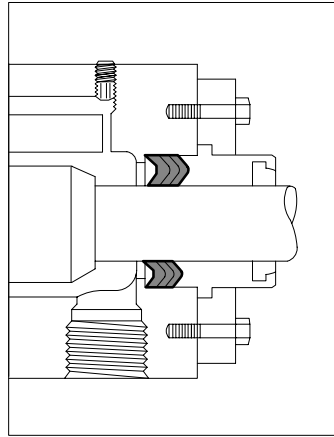

Pressure energized v-ring rod seal is standard on TE and TF cylinders. A single lip cup seal is standard on series TL.

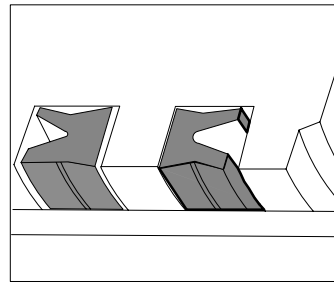

Pressure energized U-cup piston packings are standard on TE and TF cylinders. Elastomer energized glass filled Teflon rings (standard on TL cylinders) or cast iron rings are available options.

Class of hydraulic fluid	Seal compounds	
	Nitrile (standard)	Viton (optional)
Petroleum base	Compatible	Compatible
Phosphate ester	Not compatible	Compatible ●
Silicone	Compatible	Compatible
Water		
Water/oil emulsion		
Water-glycol		
Ethylene glycol		
Auto transmission fluid	Not compatible	Not compatible
Auto brake fluid		
Temperature range ■	-40° F to +250° F	-20° F to +400° F

● Except certain aircraft and commercial fluids.
■ Maximum ratings for continuous exposure of sealing system only.
The above technical data represents generally accepted design parameters. Consult Vickers Engineering for more specific application data.

Limit Switches

Two different built-in limit switches are available as options. Both come with a 1/2" pipe conduit connection in the enclosure wall.

A quick disconnect plug, factory wired to the limit switch, is an option. In addition, air-pilot valves (3-way and 2-way) can be fitted to the cylinders. See Bulletin 4098 for complete information on limit switches and valves.

Switch "01" single pole, double throw (standard)

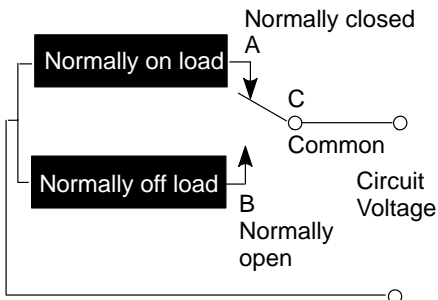

15 Amperes	125 Volts AC
	250 Volts AC
	480 Volts AC
1/8 H.P.	125 Volts AC
1/4 H.P.	250 Volts AC
1/4 Ampere	125 Volts AC
1/2 Ampere	125 Volts AC

Switch "03" single pole, double throw, double break (optional)

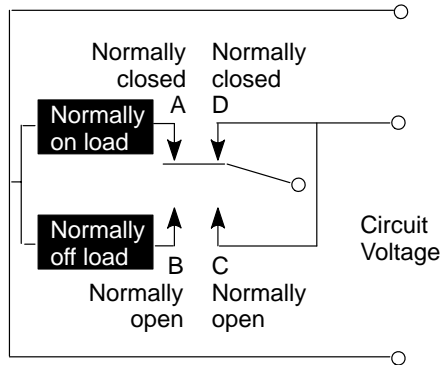
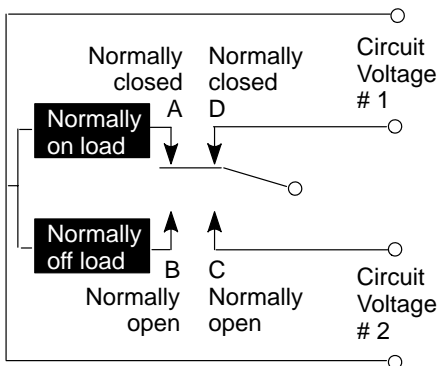

15 Amperes	125 Volts AC
	250 Volts AC
1 Ampere	125 Volts AC
1/2 Ampere	250 Volts AC
1/4 H.P.	125 Volts AC
1/2 H.P.	250 Volts AC

Switch positions

Type 01 and type 03 switches are positioned as shown below when viewing the cylinder from the head end (mounting end of double rod cylinder).

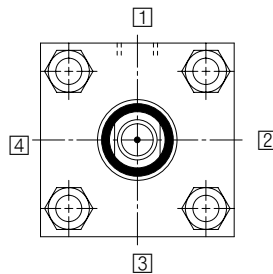

Switch type 01		
Code	Head end position	Cap end position
B	1	—
C	2	—
D	3	—
E	4	—
F	1	1
G	2	2
H	3	3
J	4	4
K	0	1
L	0	2
M	0	3
N	0	4

Switch type 03

Code	Head end position	Cap end position
5	1	1
6	2	2
7	3	3
8	4	4

Switch mounted on head end only

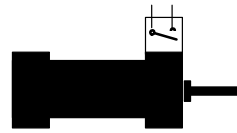

Piston rod retracted or in motion – switch open

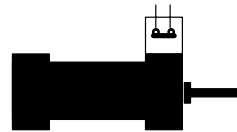

Piston rod fully extended – switch closed

Switches mounted on both head end and cap end

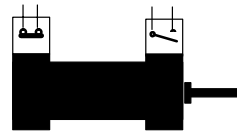

Piston rod fully retracted – cap end switch closed, head end switch open

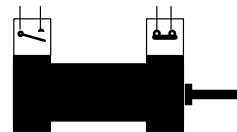

Piston rod fully extended – head end switch closed, cap end switch open

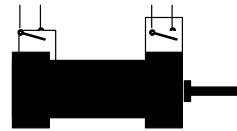

Piston rod in motion – both switches open

PS 200 Proximity Switches

PS 200 proximity switches are inductive type switches with a sensing probe that “looks” at the cylinder’s cushion collar or button to provide full extend or full retract indication. Since the probe is inside the cylinder, harsh external environments don’t affect sensing. The 2-wire circuit will operate on AC or DC and works as reliably as a programmable controller. PS 200 switches meet UL requirements for 1000 psi hydraulic cylinders. Four mounting holes allow 90° rotation increments.

Short circuit protection is a standard feature on the PS 200 proximity switch. It protects the switch from shorts in the load or line. Upon sensing a short condition, the switch assumes a non-conducting mode. The fault condition must be removed and power turned off in order to reset the switch. This feature prevents unintended automatic restarts. The switch indicates when it is in the short circuit protection mode by flashing both LEDs.

Series PS 200 2-wire AC/DC Proximity Switches

Pressure	1000 psi
Sensing range	0.08” ±10%
Operating temperature range	-20° to +70°C
Repeatability	.001”
Switching differential	10%
Supply voltage	20–220 V AC/DC
On-state voltage drop	10V @ 5–500 mA
Load current maximum	0.5 Amp
Inrush current	3 Amp
Quiescent current	1.7 mA maximum
Indicating LEDs (standard)	1 lit: Power on/non-conducting 2 lit: Target present (both flashing = short circuit protection mode)

Cable 13 Pin Plug-in Connectors for PS 200 Proximity Switches

3-foot cable	Part no. 7552-3
6-foot cable	Part no. 7552-6
12-foot cable	Part no. 7552-12

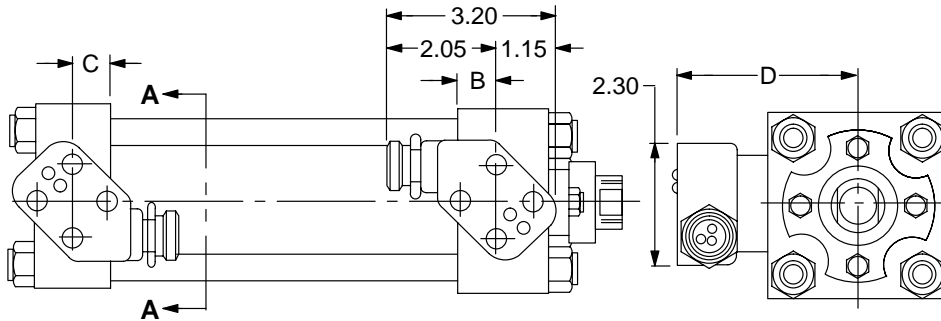

Switch is rotatable in 90° increments from position shown.

Torque .250–20 mounting screws to 12–15 ft-lb.

O-rings required:
 Size 115 – One per switch
 Size 116 – One per spacer

Bore dia. inch	Rod dia. inch	Switch 7550-	Spacer 7551-	B	C	D max
1 1/2	5/8	1.225	–	.72	–	3.43
	1	1.225	125	.72	–	3.55
	Cap end	1.725	250	–	.63	3.68
2	5/8	1.225	–	.75	–	3.68
	1	1.225	–	.75	–	3.68
	1 3/8	1.225	–	.75	–	3.74
	Cap end	1.725	–	–	.67	3.81
2 1/2	5/8	1.225	281	.72	–	3.50
	1	1.225	375	.62	–	3.61
	1 3/8	1.225	281/250	.81	–	3.77
	1 3/4	1.225	500/219	.62	–	3.95
3 1/4	Cap end	1.225	–	–	.59	3.34
	1	1.225	156	.81	–	3.75
	1 3/8	1.225	156	.81	–	3.77
	1 3/4	1.225	406	.81	–	4.00
	2	1.225	281/250	.81	–	4.13
4	Cap end	1.725	219	–	.78	3.81
	1	1.725	281	.81	–	4.25
	1 3/8	1.725	281	.81	–	4.27
	1 3/4	1.725	281/250	.81	–	4.50
	2	1.225	156	.81	–	4.13
	2 1/2	1.225	406	.81	–	4.38
Cap end	2.375	500	–	.78	4.47	

Bore dia. inch	Rod dia. inch	Switch 7550-	Spacer 7551-	B	C	D max
5	1	2.375	438	.81	–	4.91
	1 3/8	2.375	438	.81	–	4.92
	1 3/4	2.375	500/188	.81	–	5.31
	2	1.725	156	.81	–	4.63
	2 1/2	1.725	406	.81	–	4.88
	3	1.225	156	.81	–	4.63
	3 1/2	1.225	406	.81	–	4.88
6	Cap end	2.375	–	–	.78	4.47
	1 3/8	2.375	188	1.00	–	5.16
	1 3/4	2.375	188	1.00	–	5.16
	2 1/2	2.375	312/250	1.00	–	5.53
	4	1.225	156	.94	–	5.13
7	Cap end	2.875	125	–	.97	5.09
	1 3/8	2.875	188	1.00	–	5.66
	1 3/4	2.875	188	1.00	–	5.66
	3	2.375	312	.94	–	5.78
	5	1.225	156	.94	–	5.63
8	Cap end	3.750	500	–	.97	5.97
	1 3/8	3.750	312/250	1.00	–	6.53
	1 3/4	3.750	312/250	1.00	–	6.53
	3 1/2	2.875	312/250	1.00	–	6.53
	5 1/2	1.725	406	.94	–	6.38
10	Cap end	3.750	–	–	.97	5.97
	1 3/4	4.560	312/250	1.00	–	7.59
	2	4.560	312/250	1.00	–	7.59
	3 1/2	3.750	375	1.00	–	7.41
	5 1/2	2.375	–	.94	–	7.03
Cap end	4.990	250	–	.97	7.28	

Stop Tube, Tie Rod Spacers and Center Supports

Stop Tube Selection

The following table lists the maximum stroke permissible without the use of a stop tube. Strokes are listed for rigid mounting styles as well as clevis and trunnion pivot mounts.

As the stroke length of a cylinder increases, the resultant bearing loads on the piston rod become greater. To keep these bearing loads from exceeding design limitations, and to obtain optimum life from a cylinder, stop tubes should be specified according to the following procedure:

Specify one inch of stop tube for each 10 inches (or fraction thereof) of stroke in excess of the maximums listed in the table.

Bore dia. (inch)	Type of cylinder mounting		
	Pivot (clevis & trunnion)	Rigid (no rod support)	Rigid (with rod support)
1 1/2 and 2	24 in.	30 in.	48 in.
2 1/2 to 4	30 in.	38 in.	
5 to 14	36 in.	40 in.	

Stop Tube Designs

Three typical stop tube designs are illustrated below.

Design A

Used for cylinders not cushioned on the rod end.

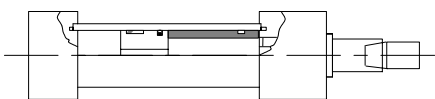

Design B

Used for cushioned hydraulic cylinders.

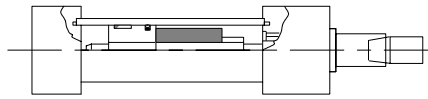

Design C

The best choice for a cylinder with an exceptionally long stop tube requirement. Note that the piston's effective bearing area is doubled, in addition to gaining the normal increased minimum distance between bearing points.

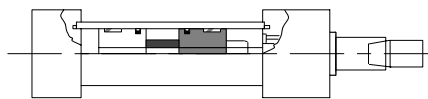

Tie Rod Spacers and Center Supports

Tie rod spacers and center supports are used to improve the structural rigidity of long stroke tie rod cylinders.

A tie rod spacer or center support should be applied when the stroke length exceeds 20 times the bore diameter.

Tie rod spacer 7

The spacers have through holes for the tie rods and are held in place on the cylinder barrel with a small tack weld or set screw.

The spacer keeps the tie rod in the proper position around the centerline of the cylinder and acts much like a truss in preventing excessive deflection in a long stroke cylinder that is not rigidly mounted (clevis mount, etc.).

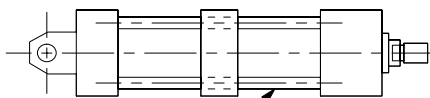

Through tie rods

Tie rod center support

The center support has side mounting lugs similar to side lug mount heads and serves as an additional mounting location. The tie rods are threaded into the center support and it becomes a load-carrying component of the cylinder assembly.

The exact location of the tie rod center support is generally optional, which greatly increases the flexibility in mounting a long stroke cylinder.

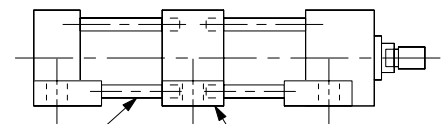

Tapped tie rods

Mounting lug similar to style 01

Selecting Cylinder Size

To choose the proper size of cylinder for your application, first determine the maximum push and/or pull force required to do the job. Then, use the table below to select the cylinder that will provide that force. Remember that force capabilities derived from charts and formulas may be theoretically correct, but other factors must be considered. Be sure to allow for pressure drop between the pump outlet and the cylinder port. Also, some of a

cylinder's force is used up overcoming seal friction and, to a lesser extent, the inertia of the piston itself. In Vickers cylinders, the amount of extra force needed to compensate for these factors has been limited to 5% or less of the cylinder's theoretical power – without sacrificing sealing performance.

For maximum reliability and fatigue life of the piston rod, the largest rod offered in a given bore size should be specified.

The smaller rods for a given bore are primarily intended for short stroke push loading or reduced pressure applications.

The chart below lists the theoretical push and pull forces that cylinders will exert when supplied with various working pressures. To calculate the theoretical forces for pressures not listed, multiply the pressure in psi times the work area shown.

Bore dia. inch	Rod dia. inch	Work area sq. in.	Hydraulic working pressure – psi										
			Air working pressure – psi					300	400	500	600	750	1000
			60	80	100	200	250						
1 1/2	–	1.767	106	141	177	353	442	530	707	884	1060	1325	1767
	5/8	1.460	88	117	146	292	365	438	584	730	876	1095	1460
	1	.982	59	79	98	196	246	294	393	491	588	737	982
2	–	3.142	189	251	314	628	786	942	1257	1571	1884	2357	3142
	5/8	2.835	170	227	284	567	709	851	1134	1418	1702	2126	2835
	1	2.357	141	189	236	471	590	707	943	1179	1414	1768	2357
	1 3/8	1.657	99	133	166	331	415	497	663	829	994	1243	1657
2 1/2	–	4.909	295	393	491	982	1228	1473	1964	2455	2946	3682	4909
	5/8	4.602	276	368	460	920	1151	1380	1841	2301	2760	3452	4602
	1	4.124	247	330	412	825	1031	1236	1650	2062	2472	3093	4124
	1 3/8	3.424	205	274	342	685	856	1026	1370	1712	2052	2568	3424
	1 3/4	2.504	150	200	250	501	626	750	1002	1252	1500	1878	2504
3 1/4	–	8.296	498	664	830	1659	2074	2490	3318	4148	4980	6222	8296
	1	7.511	451	601	751	1502	1878	2253	3004	3756	4506	5633	7511
	1 3/8	6.811	409	545	681	1362	1703	2043	2724	3406	4086	5108	6811
	1 3/4	5.891	353	471	589	1178	1473	1767	2356	2946	3534	4418	5891
	2	5.154	309	412	515	1031	1289	1545	2062	2577	3090	3866	5154
4	–	12.566	754	1005	1257	2513	3142	3771	5026	6283	7542	9425	12566
	1	11.781	707	942	1178	2356	2946	3534	4712	5891	7068	8836	11781
	1 3/8	11.081	665	886	1108	2216	2771	3324	4432	5541	6648	8311	11081
	1 3/4	10.161	610	813	1016	2032	2541	3048	4064	5081	6096	7621	10161
	2	9.424	565	754	942	1885	2356	2826	3770	4712	5652	7068	9424
	2 1/2	7.657	4594	613	766	1531	1915	2298	3063	3829	4596	5743	7657

(continued)

Bore dia. inch	Rod dia. inch	Work area sq. in.	Hydraulic working pressure – psi										
			Air Working Pressure – psi					300	400	500	600	750	1000
			60	80	100	200	250						
5	–	19.635	1178	1571	1964	3927	4909	5894	7854	9818	11784	14726	19635
	1	18.850	1131	1508	1885	3770	4713	5655	7540	9425	11310	14138	18850
	1 3/8	18.150	1089	1452	1815	3630	4538	5445	7260	9075	10890	13613	18150
	1 3/4	17.230	1034	1378	1723	3446	4308	5169	6892	8615	10338	12923	17230
	2	16.493	990	1319	1649	3299	4124	4947	6597	8247	9894	12370	16493
	2 1/2	14.726	884	1178	1473	2945	3682	4419	5890	7363	8838	11045	14726
	3	12.566	754	1005	1257	2531	3142	3771	5026	6283	7542	9425	12566
6	3 1/2	10.014	601	801	1001	2003	2504	3003	4006	5007	6006	7511	10014
	–	28.274	1696	2262	2827	5655	7069	8481	11310	14137	16962	21206	28274
	1 3/8	26.789	1607	2144	2679	5358	6698	8037	10716	13395	16074	20092	26789
	1 3/4	25.869	1552	2070	2587	5174	6468	7761	10348	12935	15522	19402	25869
	2 1/2	23.365	1402	1869	2337	4673	5842	7011	9346	11683	14022	17524	23365
7	4	15.708	942	1257	1571	3142	3927	4731	6283	7854	9426	11781	15708
	–	38.485	2309	3079	3849	7697	9622	11547	15394	19243	23091	–	–
	1 3/8	37.000	2220	2960	3700	7400	9250	11100	14800	18500	22200	–	–
	1 3/4	36.080	2165	2886	3608	7216	9020	10824	14432	18040	21648	–	–
	3	31.416	1885	2513	3142	6283	7854	9426	12566	15708	18850	–	–
8	5	18.850	1131	1508	1885	3770	4713	5655	7540	9425	11310	–	–
	–	50.265	3016	4021	5027	10053	12567	15081	20106	25133	30159	–	–
	1 3/8	48.780	2927	3902	4878	9756	12195	14634	19512	24390	29268	–	–
	1 3/4	47.860	2872	3829	4786	9572	11965	14358	19144	23930	28716	–	–
	3 1/2	40.644	2439	3252	4064	8129	10161	12192	16258	20322	24386	–	–
10	5 1/2	26.507	1590	2121	2651	5301	6627	7953	10603	13254	15904	–	–
	–	78.540	4712	6283	7854	15708	19635	23562	31416	39270	–	–	–
	1 3/4	76.135	4568	6091	7614	15227	19034	22842	30454	38068	–	–	–
	2	75.398	4524	6032	7540	15080	18850	22620	30159	37699	–	–	–
	3 1/2	68.919	4135	5514	6892	13784	17230	20676	27568	34460	–	–	–
12	5 1/2	54.782	3287	4383	5478	10956	13696	16434	21913	27391	–	–	–
	–	113.10	6786	9048	11310	22620	28275	33930	45240	56550	–	–	–
	2	109.96	6598	8797	10996	21992	27490	32988	43984	54980	–	–	–
	2 1/2	108.19	6491	8655	10819	21638	27048	32457	43276	54095	–	–	–
	4	100.53	6032	8042	10053	20106	25133	30159	40212	50265	–	–	–
14	5 1/2	89.34	5360	7147	8934	17868	22335	26802	35736	44670	–	–	–
	–	153.94	9236	12315	15394	30788	38485	46182	61576	76970	–	–	–
	2 1/2	149.03	8942	11922	14903	29806	37258	44709	59612	74515	–	–	–
	3	146.87	8812	11750	14687	29374	36718	44061	58748	73435	–	–	–
	4	141.37	8482	11310	14137	28274	35343	42411	56548	70685	–	–	–
14	5 1/2	130.18	7811	10414	13018	26036	32545	39054	52072	65090	–	–	–

Piston Velocity

The chart below lists theoretical piston velocities for cylinders supplied with 15 ft./sec. fluid velocity through standard size pipe, in hydraulic applications.

To calculate the piston velocity in inches per minute, divide the flow rate in gallons per minute by the listed fluid required per inch of stroke in gallons.

For piston velocities exceeding 5 in./sec., cushions are recommended for load deceleration.

Bore dia. inch	Rod dia. inch	Fluid required per inch of stroke		Std. NPTF port	Fluid velocity @ 15 ft./sec.	
		Gallon	Cubic foot		Flow gpm	Piston velocity in./sec.
1 1/2	–	.00765	.00102	3/8	6.6	14.4
	5/8	.00632	.00084	3/8	6.6	17.4
	1*	.00425	.00057	3/8	6.6	25.9
2	–	.01360	.00182	3/8	6.6	8.2
	5/8	.01227	.00164	3/8	6.6	9.0
	1	.01020	.00136	3/8	6.6	10.8
	1 3/8	.00717	.00096	3/8	6.6	15.3
2 1/2	–	.02125	.00284	3/8	6.6	5.2
	5/8	.01992	.00266	3/8	6.6	5.5
	1	.01785	.00239	3/8	6.6	6.2
	1 3/8	.01482	.00198	3/8	6.6	7.4
	1 3/4	.01084	.00145	3/8	6.6	10.1
3 1/4	–	.0359	.00480	1/2	11.0	5.1
	1	.0325	.00435	1/2	11.0	5.6
	1 3/8	.0295	.00394	1/2	11.0	6.2
	1 3/4	.0255	.00341	1/2	11.0	7.2
	2	.0223	.00298	1/2	11.0	8.2
4	–	.0544	.00727	1/2	11.0	3.4
	1	.0510	.00682	1/2	11.0	3.6
	1 3/8	.0480	.00641	1/2	11.0	3.8
	1 3/4	.0440	.00588	1/2	11.0	4.2
	2	.0408	.00545	1/2	11.0	4.5
	2 1/2	.0331	.00443	1/2	11.0	5.5

(continued)

Piston Velocity

Bore dia. inch	Rod dia. inch	Fluid required per inch of stroke		Std. NPTF port	Fluid velocity @ 15 ft./sec.	
		Gallon	Cubic foot		Flow gpm	Piston velocity in./sec.
5	–	.0850	.01136	1/2	11.0	2.2
	1	.0816	.01091	1/2	11.0	2.2
	1 3/8	.0786	.01050	1/2	11.0	2.3
	1 3/4	.0746	.00997	1/2	11.0	2.4
	2	.0714	.00954	1/2	11.0	2.6
	2 1/2	.0637	.00852	1/2	11.0	2.9
	3	.0544	.00727	1/2	11.0	3.4
6	3 1/2	.0434	.00580	1/2	11.0	4.2
	–	.1224	.01636	3/4	20.3	2.8
	1 3/8	.1160	.01550	3/4	20.3	2.9
	1 3/4	.1120	.01497	3/4	20.3	3.0
	2 1/2	.1011	.01352	3/4	20.3	3.3
7	4	.0680	.00909	3/4	20.3	5.0
	–	.1666	.02227	3/4	20.3	2.0
	1 3/8	.1602	.02141	3/4	20.3	2.1
	1 3/4	.1562	.02088	3/4	20.3	2.2
	3	.1360	.01818	3/4	20.3	2.5
8	5	.0816	.01091	3/4	20.3	4.1
	–	.2176	.02909	3/4	20.3	1.6
	1 3/8	.2112	.02823	3/4	20.3	1.6
	1 3/4	.2072	.02770	3/4	20.3	1.6
	3 1/2	.1759	.02352	3/4	20.3	1.9
10	5 1/2	.1147	.01534	3/4	20.3	2.9
	–	.3400	.04545	1	33.8	1.6
	1 3/4	.3296	.04406	1	33.8	1.7
	2	.3264	.04363	1	33.8	1.7
	3 1/2	.2984	.03988	1	33.8	1.9
12	5 1/2	.2372	.03170	1	33.8	2.4
	–	.4896	.06545	1	33.8	1.2
	2	.4760	.06363	1	33.8	1.2
	2 1/2	.4684	.06261	1	33.8	1.2
	4	.4352	.05818	1	33.8	1.3
14	5 1/2	.3868	.05170	1	33.8	1.4
	–	.6664	.0891	1 1/4	60.2	1.5
	2 1/2	.6452	.0862	1 1/4	60.2	1.6
	3	.6358	.0850	1 1/4	60.2	1.6
	4	.6120	.0818	1 1/4	60.2	1.6
	5 1/2	.5635	.0753	1 1/4	60.2	1.8

Maximum Allowable Push Strokes

In push applications, a cylinder acts as a loaded column. There are two basic ways to measure the column length.

Pivot mounts:

The length is measured from the pivot point to the end of the rod in the fully extended position.

Flange and other rigid mounts:

The exposed piston rod is considered to be the column length with a fixed end at the cylinder which allows longer strokes.

To use the following tables, first go to the section for your mounting style. Then locate the column which is closest to, but not below, your application's operating pressure. The intersection of operating pressure and bore/rod size represents the maximum allowable push stroke in inches. This maximum stroke is based on column loading analysis only and does not consider side loading, stop tube requirements or other cylinder stroke limiters.⁸

Bore dia. inch	Rod dia. inch	Rigid mounts (codes 01, 02, 07, 08, 12, 13, 21, 22, 23)							
		80 psig	100 psig	150 psig	250 psig	300 psig	500 psig	600 psig	1000 psig
1 1/2	5/8	88	74	62	46	41	31	28	20
	1*	255	225	175	135	120	88	79	59
2	5/8	62	55	45	34	30	22	19	12
	1	175	165	135	92	82	62	58	41
	1 3/8	360	320	250	195	165	130	120	81
2 1/2	5/8	50	43	35	27	23	16	14	6
	1	150	135	100	70	65	49	42	31
	1 3/8	275	240	197	145	130	92	85	61
	1 3/4	430	390	320	244	210	160	145	110
3 1/4	1	105	90	70	54	48	35	30	20
	1 3/8	210	180	148	110	98	70	63	45
	1 3/4	345	295	245	180	155	128	110	80
	2	425	390	300	230	205	155	145	110
4	1	80	70	56	43	37	26	21	11
	1 3/8	160	150	120	82	72	55	49	32
	1 3/4	255	245	190	143	130	91	81	61
	2	345	300	247	185	160	130	115	82
	2 1/2	555	495	396	297	252	200	180	145

(continued)

Maximum Allowable Push Strokes

Bore dia. inch	Rod dia. inch	Rigid mounts (codes 01, 02, 07, 08, 12, 13, 21, 22, 23)							
		80 psig	100 psig	150 psig	250 psig	300 psig	500 psig	600 psig	1000 psig
5	1	62	55	42	32	27	16	12	7
	1 3/8	130	120	85	64	55	41	35	20
	1 3/4	200	190	145	120	98	71	62	42
	2	265	235	190	145	133	100	84	62
	2 1/2	425	370	300	235	202	155	143	100
	3	620	555	447	420	300	245	210	157
	3 1/2	820	740	600	590	405	310	296	220
6	1 3/8	100	88	70	52	45	30	24	10
	1 3/4	175	150	130	89	79	56	49	30
	2 1/2	350	310	248	195	175	132	120	80
	4	900	800	650	500	445	335	305	245
7	1 3/8	82	75	58	40	37	22	16	–
	1 3/4	145	130	98	72	65	44	38	–
	3	440	390	300	235	210	155	145	–
	5	999	999	895	650	600	450	415	–
8	1 3/8	70	64	48	35	29	13	10	–
	1 3/4	145	120	85	63	55	35	27	–
	3 1/2	550	450	375	278	250	196	180	–
	5 1/2	–	–	900	700	640	495	430	–
10	1 3/4	92	85	65	47	37	18	–	–
	2	130	125	88	62	55	32	–	–
	3 1/2	400	355	295	220	200	147	–	–
	5 1/2	995	900	702	550	500	398	–	–
12	2	105	90	68	46	39	15	–	–
	2 1/2	165	148	120	82	70	45	–	–
	4	435	390	310	240	220	155	–	–
	5 1/2	820	710	600	450	405	310	–	–
14	2 1/2	145	130	92	65	56	26	–	–
	3	200	180	145	100	90	56	–	–
	4	360	325	255	198	185	130	–	–
	5 1/2	700	640	500	380	350	260	–	–

(continued)

Bore dia. inch	Rod dia. inch	Pivot mounts															
		Mounting codes 10, 11, 16								Mounting codes 15, 17							
		80 psig	100 psig	150 psig	250 psig	300 psig	500 psig	600 psig	1000 psig	80 psig	100 psig	150 psig	250 psig	300 psig	500 psig	600 psig	1000 psig
1 1/2	5/8	38	33	27	21	19	14	13	9	42	40	35	25	23	18	16	13
	1*	98	85	68	55	50	39	35	25	140	125	90	70	61	49	42	33
2	5/8	28	25	20	15	13	10	8.5	6	34	30	25	20	18	13	11	7
	1	70	63	51	40	36	28	25	19	190	85	68	51	49	35	31	24
	1 3/8	148	135	105	79	70	54	49	39	240	160	130	100	90	69	60	48
2 1/2	5/8	23	20	16	13	10	7	6	4	28	25	20	15	13	9	8	4
	1	58	51	41	34	29	22	19	14	71	65	55	40	38	28	25	17
	1 3/8	125	105	80	61	56	42	39	29	145	135	100	73	70	52	50	37
	1 3/4	198	180	135	100	90	70	65	49	245	205	175	140	130	90	80	60
3 1/4	1	45	39	33	24	22	15	14	8	55	50	40	30	28	20	17	11
	1 3/8	86	75	61	47	41	31	29	20	110	95	75	59	54	40	36	25
	1 3/4	145	138	100	77	70	51	49	35	180	160	140	99	90	68	60	45
	2	198	175	140	100	90	69	62	49	230	200	160	130	120	90	80	60
4	1	36	32	26	19	17	12	9.5	7	45	40	35	24	22	15	13	7
	1 3/8	69	60	50	37	34	24	21	15	85	78	61	48	42	32	24	20
	1 3/4	120	100	80	61	55	41	37	27	149	140	105	80	70	52	49	35
	2	150	135	110	80	75	58	50	37	180	160	145	100	95	70	65	48
	2 1/2	243	200	185	130	120	88	80	60	300	255	205	165	150	120	100	75
5	1	28	24	20	14	12	7	7	7	35	32	25	18	15	9	7	7
	1 3/8	52	48	40	30	25	18	15	10	69	60	50	36	33	24	20	13
	1 3/4	89	80	61	49	43	33	28	20	125	100	80	60	55	40	36	25
	2	125	104	85	61	58	45	38	26	150	140	105	80	71	55	50	35
	2 1/2	190	165	135	100	90	70	61	46	240	200	160	130	120	90	80	60
	3	255	245	195	145	140	100	90	70	350	300	248	195	160	130	120	90
	3 1/2	350	310	250	200	175	140	135	98	450	400	348	250	240	180	160	120

(continued)

Maximum Allowable Push Strokes

Bore dia. inch	Rod dia. inch	Pivot mounts															
		Mounting codes 10, 11, 16								Mounting codes 15, 17							
		80 psig	100 psig	150 psig	250 psig	300 psig	500 psig	600 psig	1000 psig	80 psig	100 psig	150 psig	250 psig	300 psig	500 psig	600 psig	1000 psig
6	1 3/8	45	39	32	23	20	13	11	10	58	50	40	30	26	18	15	10
	1 3/4	71	62	52	40	35	25	23	14	95	82	65	50	45	31	28	17
	2 1/2	145	140	110	81	75	56	50	36	199	165	140	105	89	70	65	45
	4	375	348	280	210	197	150	140	101	500	450	355	290	250	195	180	135
7	1 3/8	37	33	26	18	16	10	10	–	48	43	35	24	20	13	10	–
	1 3/4	61	55	45	32	29	19	16	–	80	70	55	40	37	25	22	–
	3	175	160	135	100	90	69	61	–	248	215	160	140	130	90	80	–
	5	505	490	385	295	255	200	180	–	650	600	490	360	348	250	240	–
8	1 3/8	33	28	22	15	13	10	10	–	41	38	28	19	16	11	10	–
	1 3/4	55	48	38	27	24	15	13	–	70	60	58	35	30	20	17	–
	3 1/2	230	195	155	135	115	81	72	–	275	250	200	155	145	120	100	–
	5 1/2	510	495	400	300	295	210	198	–	700	640	500	400	350	280	250	–
10	1 3/4	42	36	29	20	16	13	–	–	55	48	36	25	21	13	–	–
	2	58	49	39	27	24	15	–	–	70	62	50	35	30	19	–	–
	3 1/2	183	154	135	97	75	63	–	–	230	200	160	130	120	90	–	–
	5 1/2	430	395	310	250	225	175	–	–	550	500	400	300	280	220	–	–
12	2	45	40	31	21	17	15	–	–	59	50	40	25	23	15	–	–
	2 1/2	71	63	51	36	30	20	–	–	90	80	65	45	40	25	–	–
	4	195	175	145	101	90	69	–	–	248	225	160	135	115	90	–	–
	5 1/2	360	325	260	200	185	145	–	–	480	403	350	250	240	170	–	–
14	2 1/2	60	54	41	28	24	18	–	–	79	69	53	36	30	18	–	–
	3	89	79	61	45	40	25	–	–	125	100	80	60	50	31	–	–
	4	165	145	125	85	75	51	–	–	200	180	150	125	100	70	–	–
	5 1/2	300	275	225	170	155	115	–	–	390	350	280	210	190	145	–	–

Cushioning System

Vickers patented SUPER CUSHIONS incorporate several design features to permit higher cylinder speeds for increased work output and shorter cycle times. Cylinder cushions are designed to decelerate the piston velocity near the end of each cylinder stroke to prevent excessive mechanical shock.

Air Cushion

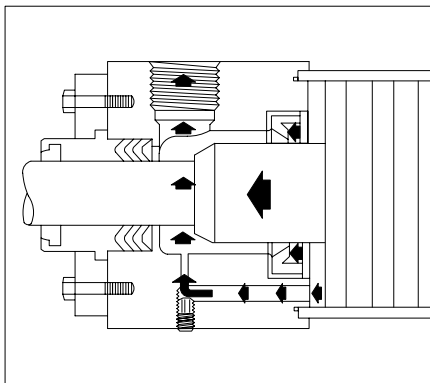

Series TE/TL cylinders employ a *flexible lip ring* at the cushion chamber entrance. As the cushion collar enters the cushion chamber, the flexible lip of the super cushion blocks the direct flow of air to the exhaust port. Exhausting air must now flow through a metered by-pass. Adjustment of the needle valve in the by-pass controls the cushioning action.

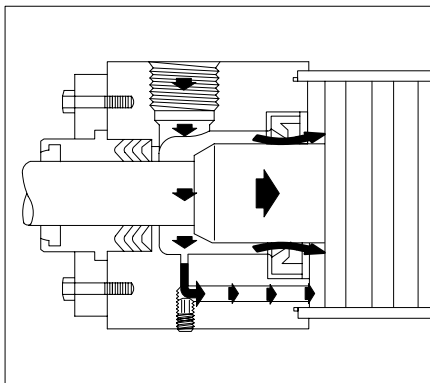

On the return stroke, air pressure blows the flexible lip of the super cushion away from the cushion collar, permitting a large volume of air to immediately reach the piston face. This allows quick acceleration and eliminates ball checks and binding between the cushion collar and cushion chamber.

Hydraulic Cushion

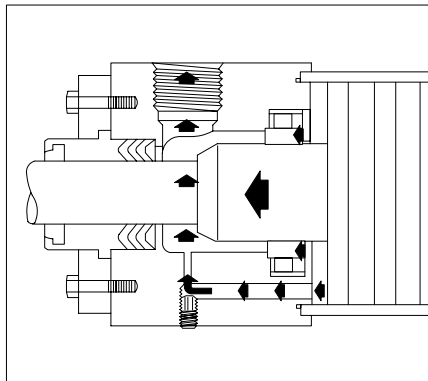

The Series TF cylinder cushion collar contacts a *floating bronze sleeve*. The floating action of the sleeve provides a very close tolerance seal contact without high loading. The sleeve seats against the head and provides a very effective seal to trap the fluid. Consistent performance and long life are provided since the radial loading on the sleeve is minimal. This sleeve can be easily replaced, if required.

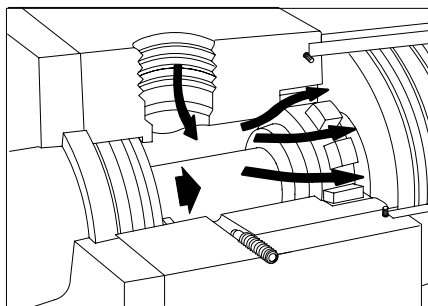

The sleeve is also free to move in an *axial* direction, and functions as a built-in fluid check which opens to permit nearly full flow for quick acceleration. When the fluid flow is reversed, the sleeve moves off its seat, and fluid may flow around the slots in the outer diameter of the sleeve.

Cylinder Weights

The following table lists the approximate net weights of TE/TF/TL cylinders.

Weights shown are based on cylinders with standard rod diameter and single rod end. All weights are expressed in pounds.

Double rod cylinder weight is equal to 1.15 times chart weight, plus weight due to stroke.

Bore dia.	Mounting style code										Add per inch of stroke	
	01, 07 & 19	02	08	10	12	13	15	16 & 17	21 & 22	23	Single rod	Double rod
1 1/2	4.6	4.3	4.8	4.4	4.8	5.2	6	4.5	4.1	4.2	.32	.41
2	6.9	6.8	7.5	6.7	7.4	8.1	8.8	6.8	6.5	6.6	.41	.50
2 1/2	10	10	10.7	9.8	10.9	11.7	12.4	9.9	9.6	9.7	.47	.55
3 1/4	19.5	19.2	20.9	19.6	21.7	23.4	21.8	18.5	18.2	18.4	.72	.94
4	27.3	27.2	29.1	27.4	30.8	32.7	29.8	26.3	26	26.2	.81	1.03
5	43.7	42.3	45.2	41.8	47.6	50.5	46.2	40.7	40.6	40.8	1.01	1.24
6	63.3	62.8	66.6	63.3	71.7	75.6	70.6	61	60.2	60.6	1.96	2.38
7	81.3	77.8	–	81.3	77.8	–	93.6	79	78.6	79.4	2.39	2.81
8	106	102	–	106	102	–	120	103	103	104	2.60	3.02
10	191	184	–	193	184	–	213	187	186	188	3.66	4.34
12	288	281	–	297	281	–	321	284	283	285	6.84	7.73
14	462	448	–	467	448	–	504	452	451	453	5.07	6.46

Hydraulic Formulas

Hydraulic work

Work = force x distance
 = pressure x area x stroke
 = pressure x volume
 = $\frac{\text{lb}}{\text{in}^2} \times \text{in}^3 = \text{in-lb}$

Hydraulic power

Power = $\frac{\text{work}}{\text{time}}$
 = pressure x $\frac{\text{volume}}{\text{time}}$
 = pressure x capacity

Horsepower input to pump

$P = \text{pressure} = \frac{\text{lb}}{\text{in}^2}$
 $Q = \text{pump capacity} = \text{gpm}$
 33,000 ft-lbs of work per minute = 1 hp
 $E = \text{pump efficiency}$
 $HP = K \times P \times Q = \frac{\text{lb/in}^2 \times \text{gpm} \times 231}{12 \times 33000 \times E}$
 $= \frac{.000583 \times P \times Q}{E} = \frac{\text{PSI} \times \text{GPM}}{1714 \times E}$

Hydraulic Cylinder Formulas

Pressure and force

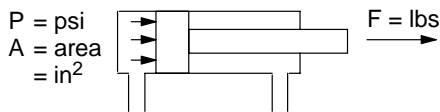

Force = pressure x area
 $F = P \times A$
 $= \frac{\text{lbs}}{\text{in}^2} \times \text{in}^2 = \text{lbs}$

Rate of cylinder travel

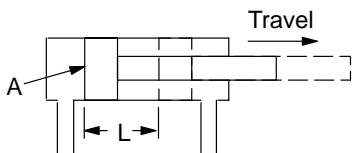

$A = \text{cap area} = \text{in}^2$
 $L = \text{cylinder stroke} = \text{in}$
 $V = \text{volume traversed} = LA$
 $Q = \text{pump capacity} = \frac{\text{cu in}}{\text{sec}}$
 $T = \text{time} = \frac{\text{volume traversed}}{\text{pump capacity}} = \frac{V}{Q} = \frac{\text{in}^3}{\text{in}^3/\text{sec}} = \text{sec}$
 $R = \text{rate of piston travel} = \frac{\text{in}}{\text{sec}} = \frac{L}{T}$
 $R = \frac{L}{T} = \frac{L}{V/Q} = \frac{QL}{V} = \frac{QL}{LA} = \frac{Q}{A}$

Quantity of flow

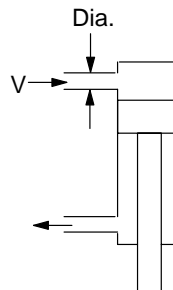

$V = \text{fluid velocity} = \text{ft/sec}$
 $D = \text{pipe diameter} = \text{inches}$
 $Q = \text{quantity of flow} = \text{gpm}$
 $\frac{\text{ft}}{\text{sec}} \times 12 = \frac{\text{inches}}{\text{sec}}$
 $\text{gpm} \times \frac{231}{60} = \frac{\text{cu in}}{\text{sec}}$
 $\frac{\pi D^2}{4} = \text{pipe area} = \text{in}^2 = A$
 $Q = AV = \text{in}^2 \times \frac{\text{in}}{\text{sec}} = \frac{\text{cu in}}{\text{sec}}$

